

JVC

SERVICE MANUAL

MODEL
R-X60

DIGITAL SYNTHESIZER
STEREO RECEIVER

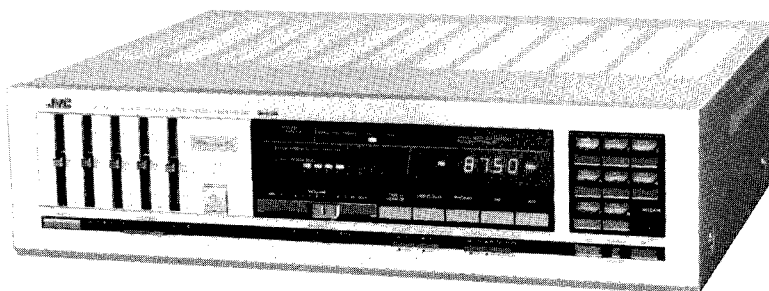

No. 2607
APR. 1982

Contents

1. Specifications	1	8-(3) TDC-65□ Display P.C. Board Ass'y	16
2. Names of Parts and Their Functions	2	8-(4) TAC-532A SEA Control P.C. Board Ass'y	17
3. Main Parts Locations	4	8-(5) TXX-403□ Pre Amp P.C. Board Ass'y	19
3-(1) Top View	4	8-(6) TPS-333□ Fuse, Power Supply & AC Outlet P.C. Board Ass'y	21
3-(2) Front View	4	9. R-X60 Schematic Diagram	22
3-(3) Rear View	4	9-(1) Tuner & Pre Amp Section	22
4. Removal Procedures.	5	9-(2) Power Amp & Power Supply Section	23
4-(1) Removal Procedures of Power Transistors	5	9-(3) Logic Control Section	24
4-(2) Connection Diagram	5	10. Packing Materials and Part Numbers	25
5. Adjustment Procedures.	6	11. Accessories List.	25
5-(1) FM/AM Tuner	6	12. Parts List with Specified Numbers for Designated Areas.	back cover
5-(2) Power Amplifier Idling Current	7		
6. Block Diagram	8		
7. Exploded Views and Part Numbers	9		
8. Printed Circuit Board Ass'y and Parts List	10		
8-(1) TFC-38□ Tuner P.C. Board Ass'y	10		
8-(2) TXX-402□ Power Amp P.C. Board Ass'y	13		

Warning: When replacing the parts marked with \triangle , be sure to use the designated parts to ensure safety.

1. Specifications

FM Tuner Section (Figures are based upon IHF Standard)

Tuning Range	: 87.5 MHz — 108.0 MHz
Usable Sensitivity (IHF)	: 10.3 dBf (1.8 μ V/300 ohms)
50 dB quieting Sensitivity	
Mono	: 14.8 dBf (3 μ V/300 ohms)
Stereo	: 37.2 dBf (40 μ V/300 ohms)
Distortion	
Mono	: 0.1% (1 kHz)
Stereo	: 0.15% (1 kHz)
Signal to Noise Ratio (at 98 MHz, 80 dBf input)	
Mono	: 83 dB (IHF A-network weighted) (74 dB, DIN)
Stereo	: 74 dB (IHF A-network weighted) (65 dB, DIN)
Selectivity	: 75 dB, \pm 400 kHz (60 dB, 300 kHz, DIN)
Capture Ratio	
(80 dBf input)	: 1.5 dB
IF Rejection	: 100 dB at 98 MHz
Image Rejection	: 80 dB at 98 MHz
Stereo Separation	: 45 dB at 1 kHz

AM Tuner Section

Tuning Range	: 520 — 1710 kHz (for 10 kHz step) (522 — 1611 kHz for 9 kHz step)
Usable Sensitivity	: 50 μ V (External Antenna) 250 μ V/m at 1000 kHz (999 kHz)
Signal to Noise Ratio	: 50 dB at 1000 kHz (100 mW/m)
Distortion	: 0.5% at 100 mV/m
Selectivity	: 63 dB \pm 10 kHz (at 1000 kHz) (60 dB \pm 9 kHz, DIN)

Amplifier Section

Output Power and Total Harmonic Distortion	: 55 watts per channel, min. RMS, both channels driven, into 8 ohms from 20 Hz to 20 kHz, with no more than 0.008% total harmonic distortion 65 (58) watts per channel, min. RMS, both channels driven, into 8 ohms at 1 kHz with no more than 0.7% (0.003%) total harmonic distortion
--	---

Input Sensitivity/Impedance

Phono	: 2.5 mV/47 kohms
Tape Play, Video/Aux	: 210 mV/50 kohms
Tape Play (DIN)	(210 mV/50 kohms)
SEA control	
Center Frequencies	: 63 Hz, 250 Hz, 1 kHz, 4 kHz, 16 kHz
Control Range	: \pm 12 dB
Loudness Control	: +7 dB at 50 Hz
(Volume control at -40 dB position)	+4 dB at 10 kHz
Signal to Noise Ratio	: Phono (MM) 77 dB
(IHF short-circuited A-network)	(IHF A-202 80 dB) Tape Play/Video/Aux 98 dB (IHF A-202 75 dB)

Design and specifications subject to change without notice.

Power Specifications

Areas	Line Voltage & Frequency	Power Consumption
U.S.A. & Canada	AC 120 V~60 Hz	260 Watts 315 VA
Europe	AC 220 V~50 Hz	450 Watts
Australia & U.K.	AC 240 V~50 Hz	450 Watts
Other Areas	AC 110/120/220/ 240 V~Selectable, 50/60 Hz	450 Watts

Dimensions and Weight

Model	Height	Width	Depth	Weight
R-X60	117 mm (4-19/32")	435 mm (17-1/8")	370 mm (14-9/16")	8.3 kg (18.3 lbs)

2. Names of Parts and Their Functions

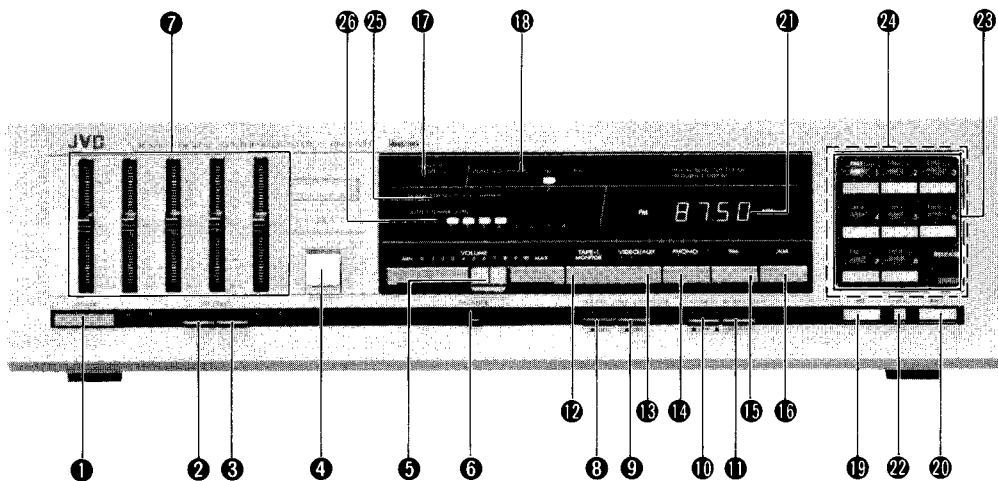

Fig. 1

1 POWER switch

ON: Press to turn the power on. The power indicator "Super A" lights and the display panel is illuminated. During the first 4 or 5 seconds after the POWER switch is turned on, no sound will be heard until you hear the "click" of the relay operating. This is not due to any defect in the unit; the power protection circuit operates to mute switching noise to protect the speaker.

Note: An electronic source selector is used in this unit. When the POWER switch is first switched ON, two or more or no source may be selected. Make sure to input the source select data by pressing one of the source selectors.

STAND BY: As long as the power cord is plugged into an AC outlet, source selector and preset station data are not cancelled or altered. They are maintained even in the case of a power failure or when the power cord is disconnected, if the period power is not supplied does not exceed a couple of days.

2, 3 SPEAKERS switches

1: Press in (—) to listen to the speakers connected to the SYSTEM-1 speaker terminals.

2: Press in (—) to listen to the speakers connected to the SYSTEM-2 speaker terminals.

1, 2: Press switches 1 and 2 in (—) to listen to both speaker systems simultaneously.

OFF: Depressing switch 1 or 2 again sets it out (■) and turns off the corresponding speaker sound; with both speakers switched off, you can listen through headphones.

4 PHONES jack

Flip up the cover and plug stereo headphones into this jack for private listening.

Note: Plugging in the headphones does not switch off speaker sound. To listen through headphones without speaker sound, set the SPEAKERS switches to OFF.

5 VOLUME control

Slide to the right to increase the sound volume.

6 BALANCE control

Slide to balance the left and right speaker volume. When it is at the extreme left, only the left channel is heard, and vice versa.

7 S.E.A. Graphic Equalizer system

These five controls allow you to individually boost or lower five portions of the frequency spectrum by 12 dB. For operation of these controls, which give far more flexible control over tone than the conventional bass/treble controls. The preset patterns add to your listening pleasure with different types of music.

8 SEA REC switch

Press to record tapes with the added effect of the S.E.A. Graphic Equalizer.

9 TAPE-2 MONITOR switch

Press to listen to or monitor a tape deck connected to the TAPE-2 terminals (—); the TAPE-2 indicator lights. Press it again (■) to disengage.

10 LOUDNESS switch

At low volumes, certain tones seem to change. This is not due to any altering in the sound at lower volumes. Press this switch to compensate for this apparent alteration in sound when you are listening at lower volumes.

11 MODE/SCAN switch

This switch is used to select both FM STEREO/MONO mode and AUTO/MANUAL scanning mode. These functions are related to each other. When stereo reception is possible, set this switch to STEREO/AUTO (■) for auto tuning. When signals are too weak to be received, set to MONO/MANU (—) for manual tuning; in this mode the left and right channel FM signals are mixed and heard from both speakers.

12 TAPE-1 MONITOR switch

Press to listen to or monitor a tape deck connected to the TAPE-1 terminals or the TAPE-1 DIN socket; the TAPE-1 indicator lights. Press this again to listen to the source selected with the source selectors; the indicator will go out.

13, 14, 15, 16 Source selectors (VIDEO/AUX, PHONO, FM, AM)

VIDEO/AUX: Press to listen to sources connected to the rear panel VIDEO/AUX terminals.

PHONO: Press to listen to records on a turntable connected to the rear panel PHONO terminals.

FM: Press to switch on the FM tuner section.

AM: Press to switch on the AM tuner section.

17 TAPE indicators

These indicators correspond to the TAPE MONITOR switches and light when you are monitoring or listening to tape recordings. If you press both TAPE-1 MONITOR and TAPE-2 MONITOR switches simultaneously, these indicators show only TAPE-1.

Note: When listening to the source selected by source selector, make sure that the TAPE indicators are off.

18 Source indicators (AUX, PHONO, FM, AM)

One of these lights when the corresponding source is selected.

19, 20 UP/DOWN TUNING button

Auto tuning

Up-scanning button (▶): When this button is pressed, beeps will be heard and the tuned frequency changes in the direction of increasing frequencies. Use this button to search the upper frequency broadcast. Scanning (Auto Tuning) stops automatically when the next FM (or AM) station is pulled in. This tuned-in frequency is displayed digitally by the frequency indicator.

Down-scanning button (◀): Press to tune in the direction of decreasing frequencies. Use this button to search the lower frequency station. Functions are identical with those of the up-scanning button.

Note: When the upper or lower frequency limit of the band is reached, scanning starts in the opposite direction. If you continue to press the scanning button when the upper or lower frequency limit of the band has been reached, scanning will stop. When this button is held pressed, scanning does not stop even if there are stations.

If one of these buttons is pressed right after the AM or FM source select button, the tone of the beep will differ.

Manual tuning

Manual tuning is used when the station required is too weak to be received by auto tuning. Press the MODE/SCAN switch (1). Now pressing either of the scanning buttons changes the frequency in predetermined steps (see table). Tapping this button changes the tuned frequency step by step, continuous pressing (more than 0.6 sec.) changes tuning to high speed scanning sequence which stops when the button is released.

Note: When manual tuning is used, it does not automatically reverse the direction of scanning when the upper or lower frequency limit of the band is reached.

Channel spacing

An AM channel spacing switch (U.S.A., Canada and other areas models) is provided on the rear panel for selecting 9 kHz or 10 kHz steps according to the channel spacing in your area. To change AM channel spacing, set the POWER switch to the STANDBY position (■) then change the position of the AM channel spacing switch.

Area \ Band	FM	AM
U.S.A., Canada	100 kHz	*10 kHz/9 kHz
Continental Europe, U.K.	50 kHz	9 kHz
Other areas	*50 kHz/100 kHz	*9 kHz/10 kHz

Notes

- *Preset at the factory.
- In some countries in "Other areas", AM channel spacing must be changed. Follow this procedure.

21 Frequency indicator

The tuned-in frequency is displayed digitally. Four digits (kHz) are displayed for AM reception and five digits (MHz) (for Europe, UK, Australia and other countries) or four digits (MHz) (for U.S.A., Canada) are displayed for FM reception.

22 MEMORY button

When this button is pressed, the MEMORY indicator lights. If the station select button is pressed while this indicator is lit, the frequency of the station being received is displayed and becomes preset to that channel. When the station select button is pressed after this indicator goes out, the frequency of the previously preset station is displayed on the frequency indicator. In that case, perform tuning once again and press the MEMORY button.

23 Station select buttons/station indicators

These buttons are used to select one of the preset stations or to preset the station for an individual channel. For presetting, press one of these buttons while the MEMORY indicator remains lit after the MEMORY button has been pressed. Then the station which is being received will be stored in memory. One of the STATIONS indicators will light to show which channel is in operation.

Each of the station select buttons can be used for one FM station and one AM station. When the MEMORY indicator is not lit, press one of these buttons, a beep will be heard, to receive the station held in memory.

Notes:

- Do not leave preset channels unoccupied as this may cause mistuning.
- Do not press the MEMORY button and the preset button at the same time. Be sure to release the MEMORY button and then press the preset button.
- When storing a frequency in memory, a beep is not heard when the station select button is pressed.

24 Station select button window

This window can be removed by lifting up the release lever and pulling it toward you. Put the provided station (frequency) identifier sheet from the back and the each station (frequency) corresponding to the station select button will be indicated.

25 SIGNAL strength indicator

This is used in tuning to both FM and AM broadcasts. The more the number of lamps that light, the stronger the signal being received.

26 OUTPUT POWER LEVEL indicator

These indicate the output power level.

3. Main Parts Locations

3-(1) Top View

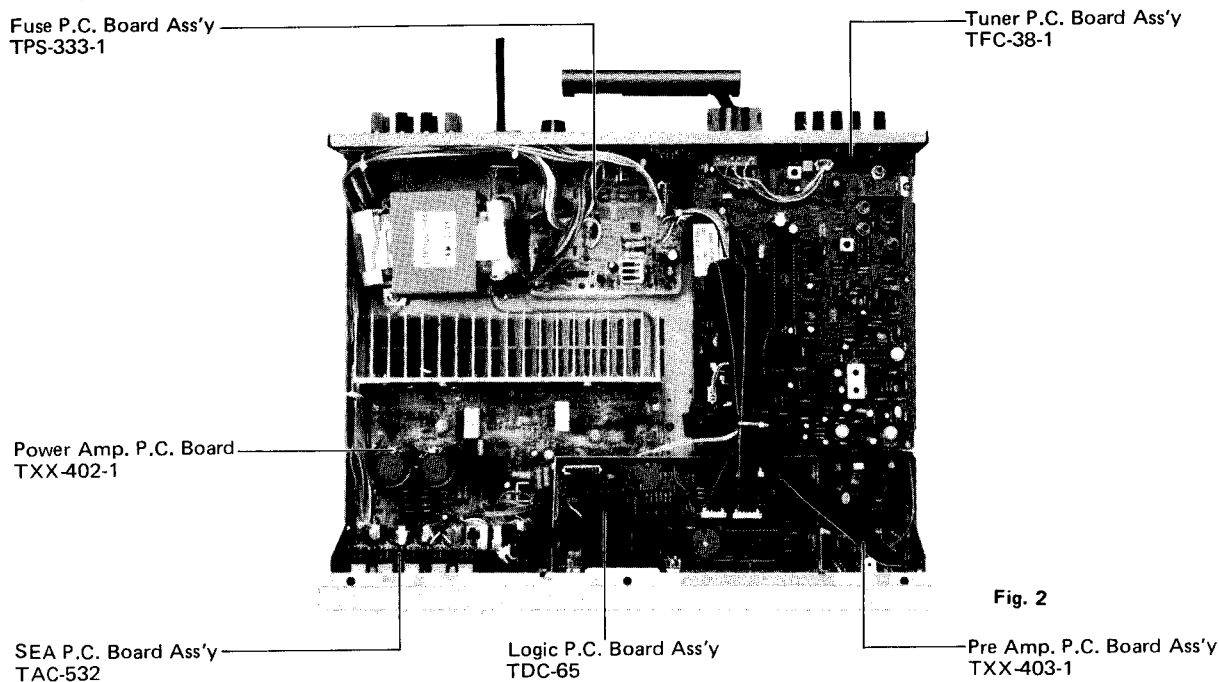

Fig. 2

3-(2) Front View

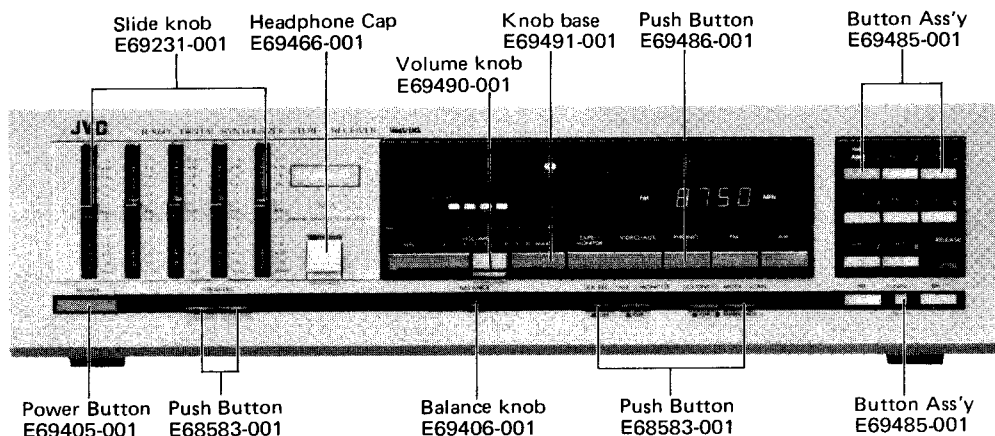
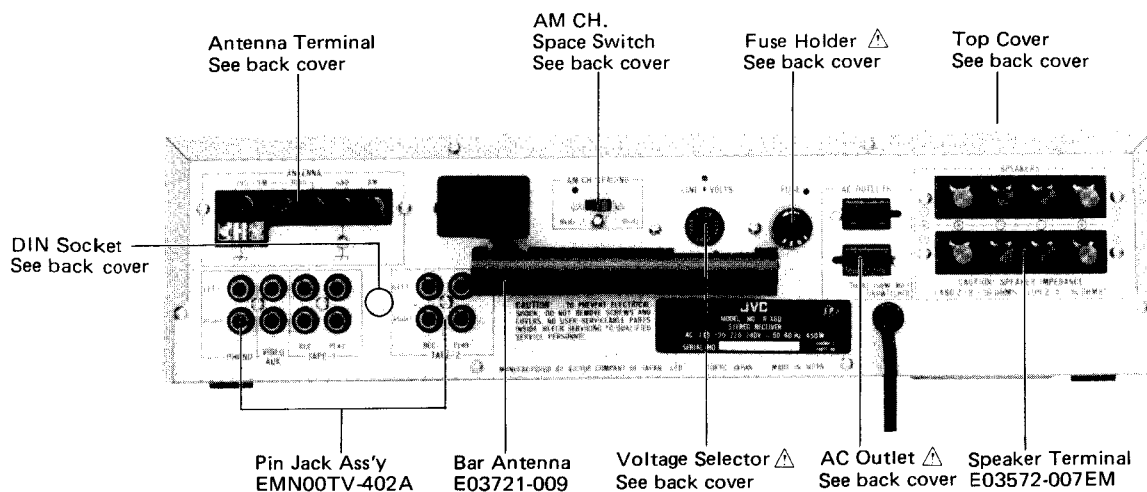

Fig. 3

3-(3) Rear View



4. Removal Procedures

4-(1) Removal Procedures of Power Transistors

When replacing power transistors, take out the power board.

1. Remove the front panel.
2. Remove the connectors on the S.E.A. and logic boards.
3. Remove the S.E.A. escutcheon, then remove the volume board.
4. Remove the two securing screws (A) of the logic board (Fig. 5), then pull out the logic board forward.
5. Remove the two bracket securing screws (B) on the logic board (Fig. 5), then remove the bracket.
6. Remove the six push-switch securing screws (C) on the power board. (Fig. 5).
7. Remove the securing nut (D) of the headphones jack.
8. Take out the power board as shown in Fig. 6; and replace power transistors.

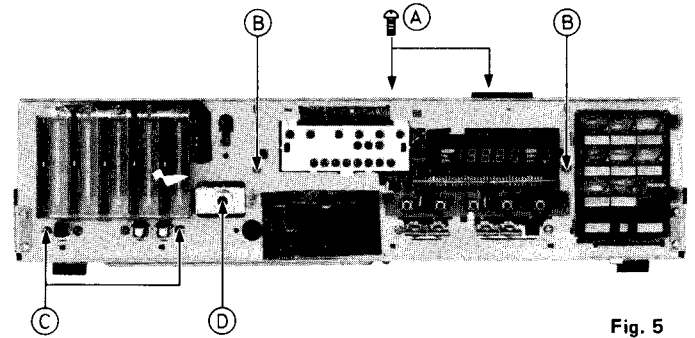

Fig. 5

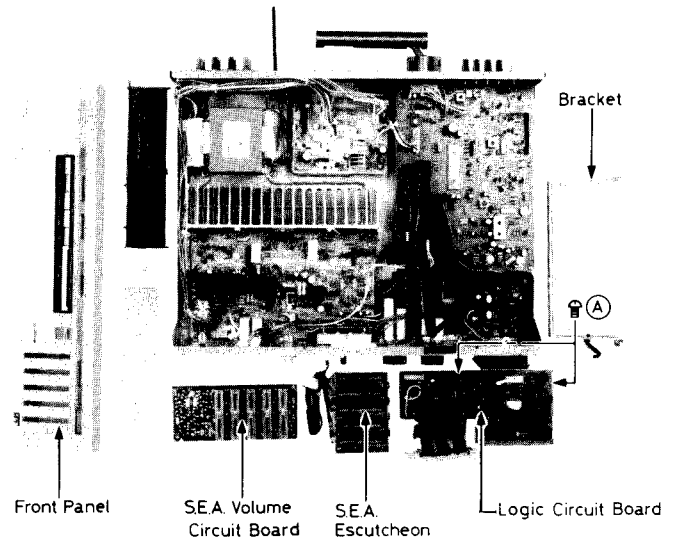

Fig. 6

4-(2) Connection Diagram

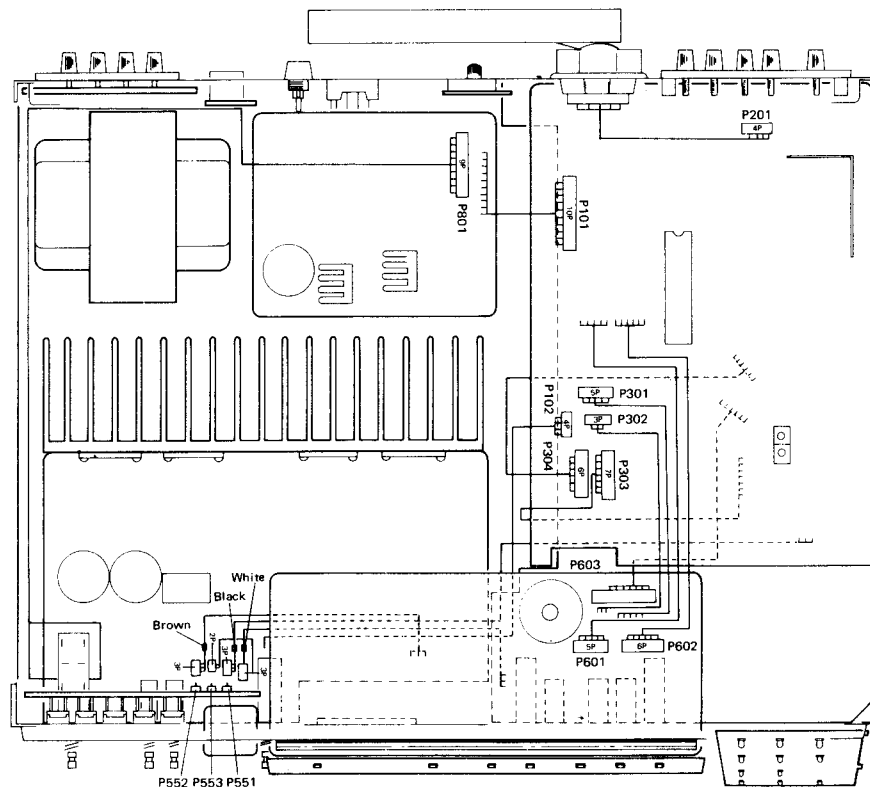

Fig. 7

5. Adjustment Procedures

5-(1) FM/AM Tuner

Adjustment Location of TFC-38 FM/AM Tuner
P.C. Board Ass'y

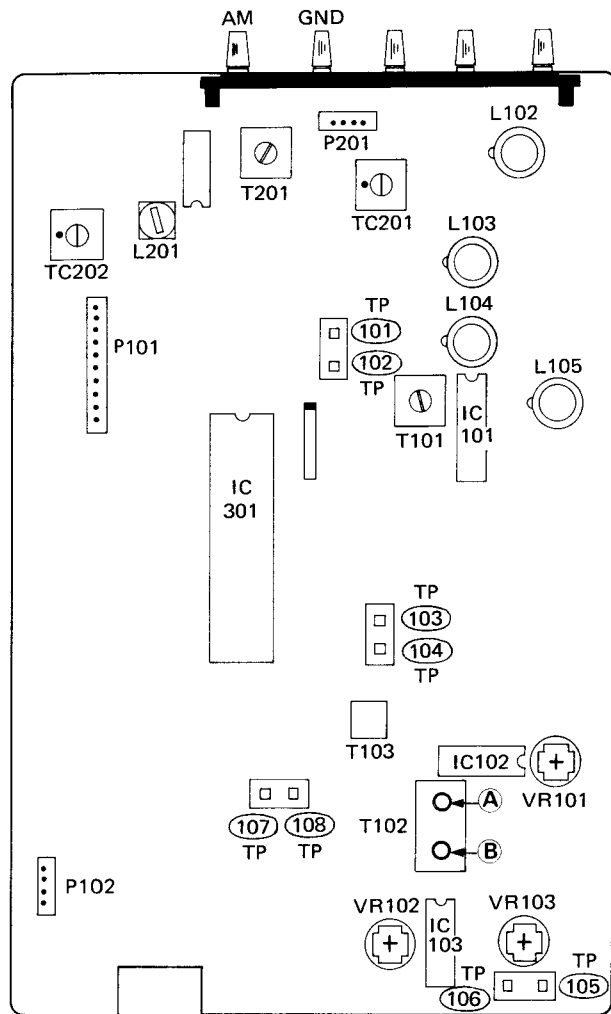

Fig. 8

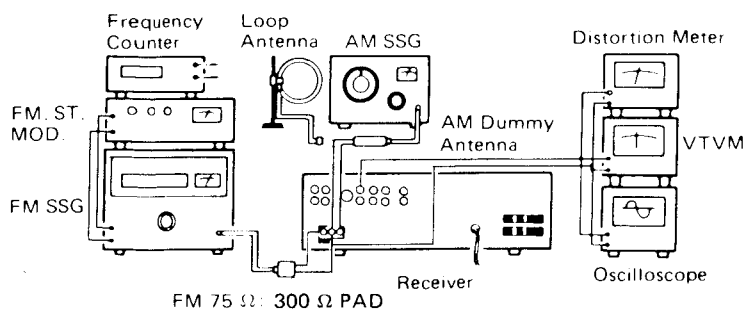

Fig. 9

FM Section

Sensitivity

1. Press to "FM" position.
2. Set the frequency display to 108.0 MHz.
3. Connect a DC VTVM between TP-101 and TP-102 (GND), adjust L105 so that the DC VTVM indicates 22.0 V.
4. Connect an RF generator to 300 Ω antenna terminals on the rear panel through a dummy antenna (FM 75 Ω : 300 Ω PAD).
5. Set the RF generator to 98 MHz, a modulation of 1 kHz and a deviation of 75 kHz to provide an input of 2 μ V.
6. Connect a VTVM and an oscilloscope to "TAPE-1/REC" jacks on the rear panel.
Note: Set the VTVM to "1 V range" and the oscilloscope to "1 mV/DIV".
7. Set the frequency display to 98.0 MHz.
8. Adjust L102, L103, L104 and T101 until the maximum sensitivity is obtained.

Discriminator and Distortion

1. Connect an RF generator set to 1 kHz modulation and 75 kHz deviation to the antenna terminals on the rear panel through a dummy antenna.
2. Connect an oscilloscope, distortion meter and AC VTVM to the "TAPE-1/REC" jacks on the rear panel.
3. Set the RF generator to 98 MHz and output of 1 mV.
4. Set the frequency display to 98 MHz.
5. Connect a DC VTVM between TP-103 and TP-104.
6. Adjust the core indicated arrow **A** of T102 for DC VTVM reading of 0 (zero) mV.
7. Adjust the core indicated arrow **B** of T102 so that the distortion is minimized at a value less than 0.2%.
8. Repeat procedures "6" and "7" alternately until minimum distortion and DC VTVM reading of 0 (zero) mV are obtained.

Multiplex Stereo Distortion and Stereo Separation

Multiplex

1. Set the stereo signal generator as follows: 400 Hz Modulation frequency, 7.5 kHz deviation pilot, 67.5 kHz main and sub carriers. Connect its output to an RF generator.
2. Connect the RF generator to the antenna terminals through a dummy antenna.
3. Connect an AC VTVM, an oscilloscope and a distortion meter to the "TAPE-1/REC" jacks on the rear panel.
4. Set the RF generator to 98 MHz and output of 1 mV.
5. Set the frequency display to 98 MHz by AUTO TUNING (UP or DOWN).
6. Connect a frequency counter between TP-105 and TP-106 (GND).
7. Switch off the pilot signal of stereo modulator.
8. Adjust VR103 so that the frequency counter indicates 76 kHz (+0 ~ - 200 Hz).

Stereo Distortion

9. Switch the selector of stereo modulator to left channel modulation.
10. Adjust T101 so that the distortion of left channel is minimized at a value less than 0.4%.

Stereo Separation

11. Switch the selector of stereo modulator to left channel modulation.
12. Adjust VR102 so that the output of right channel is minimized.
13. Switch the selector of the modulator to right channel modulation.
14. Adjust VR102 so that the output of left channel is minimized.
15. Set VR102 to an average, if the separations of left and right channels are different.

AM Section

Tracking and Sensitivity

Note 1: () for adjustment frequency of 9 kHz AM channel spacing.

Note 2: AM channel spacing of 10 kHz for U.S.A., Canada and U.S. Military Market.
 AM channel spacing of 9 kHz for Europe, Australia, U.K. and Other Countries.

1. Press to "AM" position.
2. Connect the RF generator to the antenna terminals on the rear panel through a dummy antenna.

3. Connect an AC VTVM and an oscilloscope to the "TAPE-1/REC" jacks on the rear panel.
4. Set the frequency display to 520 kHz (522 kHz). Connect the DC VTVM between TP101 and T102 (GND), adjust L201 for DC VTVM reading of 1.76 V (1.8 V)
5. Set the frequency display to 1610 kHz (1611 kHz). Adjust TC202 for DC VTVM reading of 20.9 V (21.0 V).
6. Repeat procedures "5" and "6" alternately until specified voltage is obtained.
7. Set the RF generator to 600 kHz (603 kHz), a modulation of 400 Hz and modulated 30%.
8. Set the frequency display to 600 kHz (603 kHz).
9. Set the RF generator's output to 30 dB, adjust T201 and the ferrite bar antenna adjusting the coil to maximize the output signal.
10. Set the RF generator to 1400 kHz (1404 kHz), a modulation of 400 Hz and modulated 30%.
11. Set the frequency display to 1400 kHz (1404 kHz).
12. Set the RF generator's output to 30 dB (50 dB/m), adjust trimmer TC201 in the tuning gang so that the output signal is maximized.
13. Repeat these high and low frequency adjustment procedures alternately until maximum sensitivity is obtained.

5-(2) Power Amplifier Idling Current

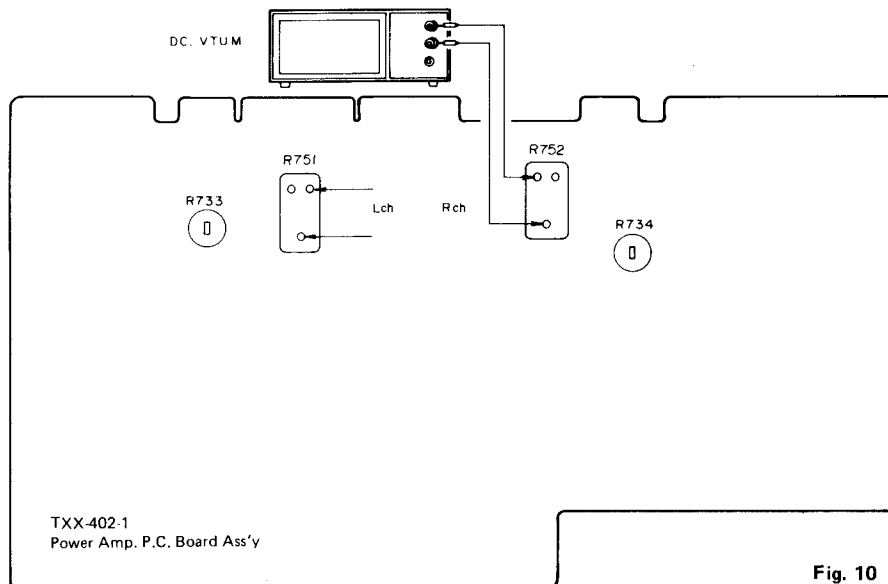

Fig. 10

Precaution

1. Turn R733 and R734 fully counterclockwise before the power switch on.
2. Allow the set warm up at least 5 minutes before adjustment.
3. Must keep the heatsink to prevent overheating before adjustment.
4. Set the volume control to minimum during this adjustment.

Adjustment

5. Connect a DC VTVM to R751 resistor's leads for left channel, or to R752's leads for right channel.
6. Adjust R733 for left channel, or R734 for right channel, so that the DC VTVM reads 5 mV.

6. Block Diagram

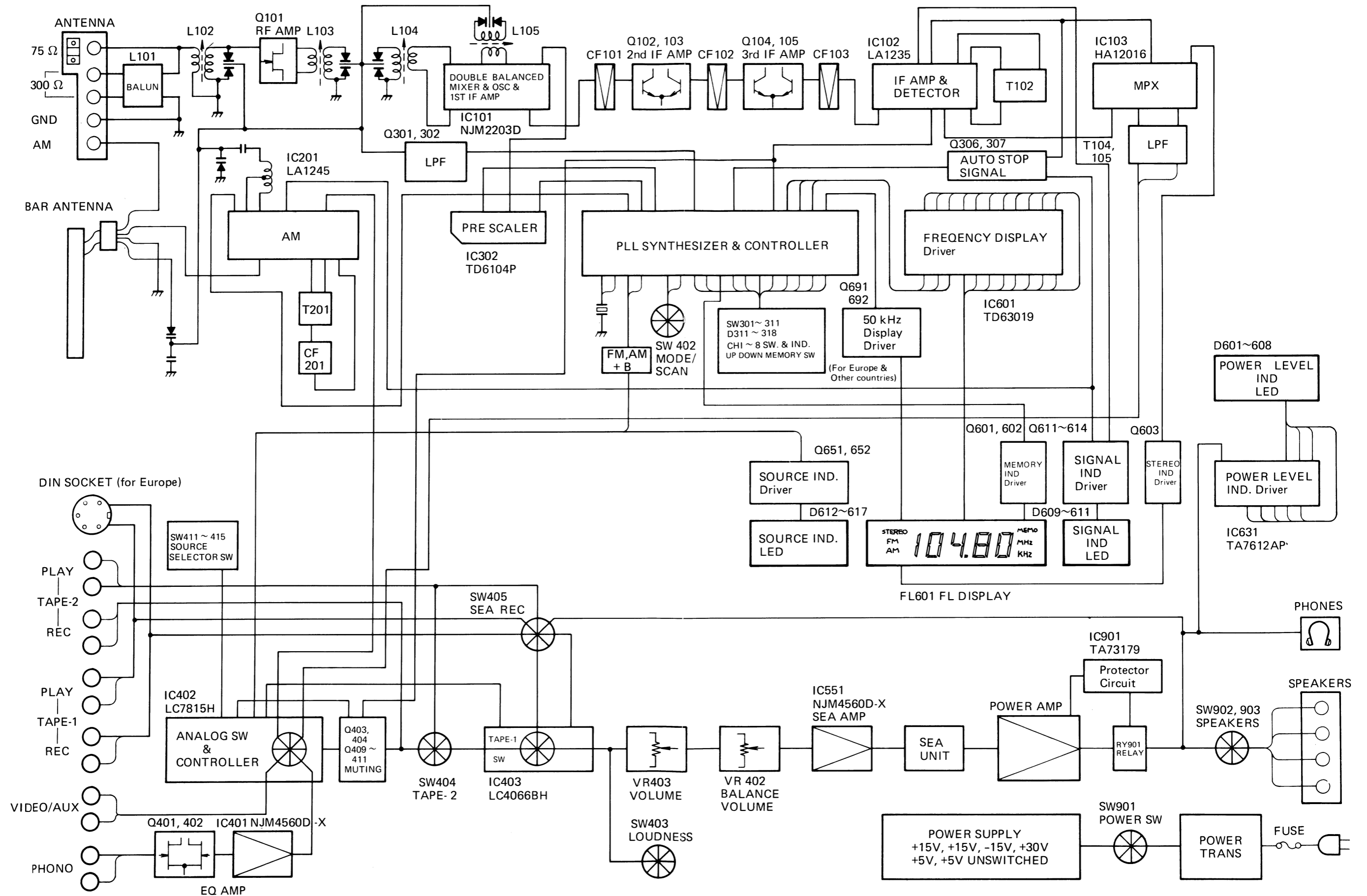
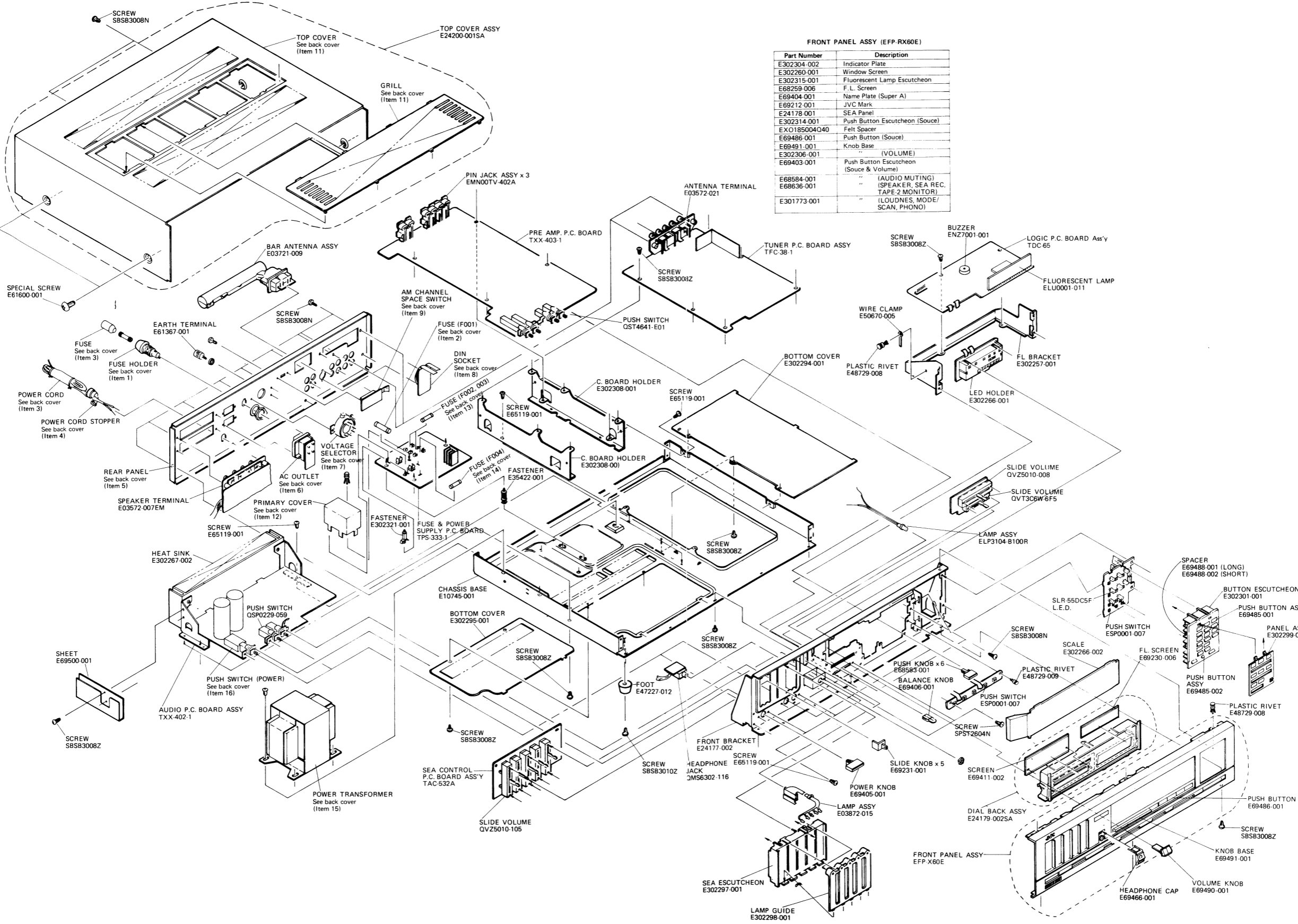

Fig. 11

7. Exploded Views and Part Numbers



FRONT PANEL ASSY (EFP RX60E)

Part Number	Description
E302304-002	Indicator Plate
E302265-001	Window Screen
E302315-001	Fluorescent Lamp Escutcheon
E68259-006	F.L. Screen
E69404-001	Name Plate (Super A)
E69212-001	JVC Mark
E24178-001	SEA Panel
E302314-001	Push Button Escutcheon (Source)
EXO185004040	Felt Spacer
E69486-001	Push Button (Source)
E69491-001	Knob Base
E302306-001	" (VOLUME)
E69403-001	Push Button Escutcheon (Source & Volume)
E68584-001	" (AUDIO MUTING)
E68636-001	" (SPEAKER, SEA REC. TAPE 2 MONITOR)
E301773-001	" (LOUDNES, MODE/SCAN, PHONE)

Fig. 12

8. Printed Circuit Board Ass'y and Parts List

8-(1) TFC-38 Tuner P.C. Board Ass'y

Note: TFC-38 □-1 varies according to the areas employed. See note (1).

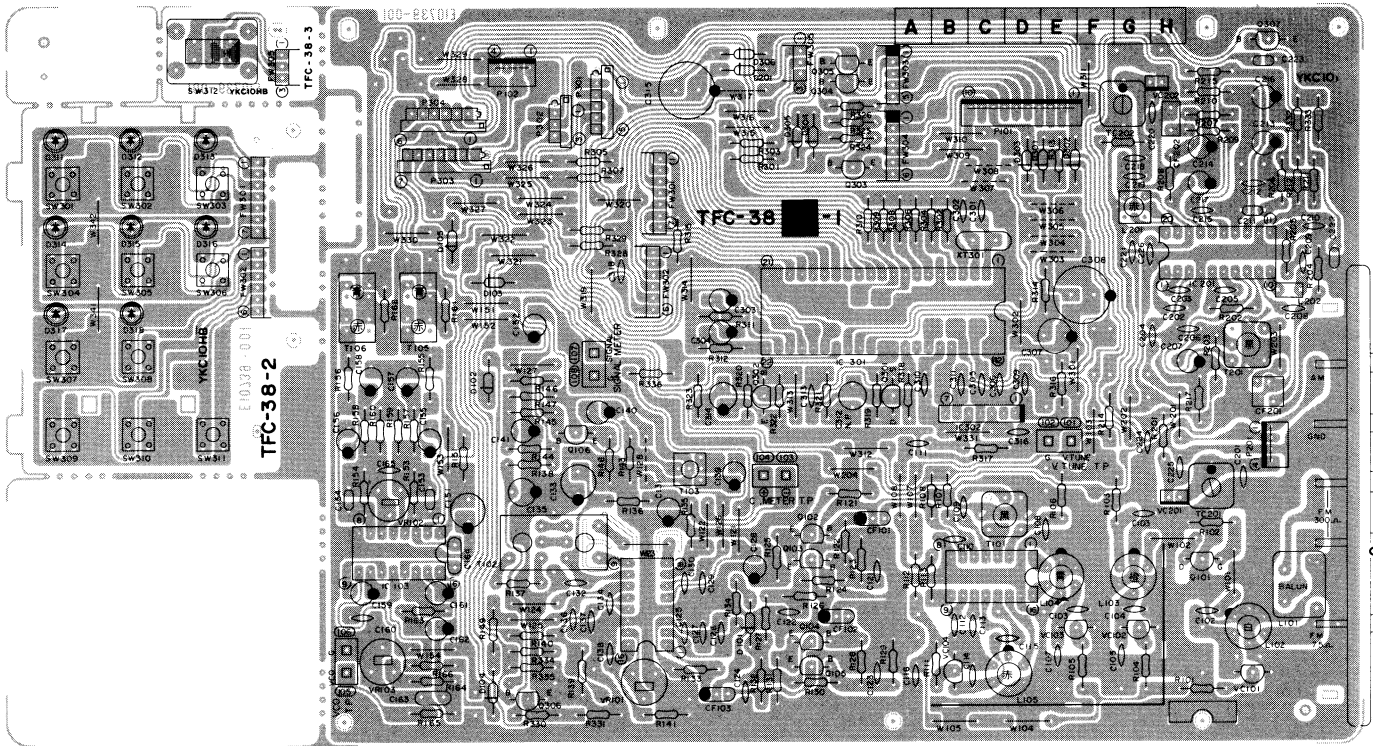

Fig. 13

Each Individual P.C. Board Location

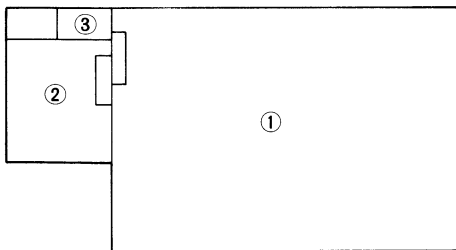

Fig. 14

- ① TFC-38-1 Tuner & Synthesizer P.C. Board Ass'y
- ② TFC-38-2 Memory & Preset Switch P.C. Board Ass'y
- ③ TFC-38-3 AM Channel Step Select Switch P.C. Board Ass'y

Note (1)

Designated Areas	P.C. Board Ass'y
U.S.A. & Canada	TFC-38 A
U.S. Military Market & Other countries	TFC-38 B
U.K., Australia, & Europe	TFC-38 C
West Germany	TFC-38 D

Note (2)

The symbols (赤, 黒, 白 . . . etc) on P.C. Board surface are factory process only.

Transistors

Item No.	Part Number	Rating	Description	
				Maker
Q101	2SK168 (F)		F.E.T	Hitachi
Q102	2SC461 (C)		Silicon	"
Q103	2SC461 (C)		"	"
Q104	2SC461 (C)		"	"
Q105	2SC461 (C)		"	"
Q106	2SC1775AV (E, F)		"	"
Q301	2SK246 (Y)		F.E.T.	Toshiba
Q302	2SC945A (P, Q)		Silicon	NEC
Q303	2SA733A (P, Q)		"	"
Q304	2SA733A (P, Q)		"	"
Q305	2SA733A (P, Q)		"	"
Q306	2SC945A (P, Q)		"	"
Q307	2SC945A (P, Q)		"	"
Q308	2SC1685 (Q, R)		"	Matsushita

Integrated Circuits

Item No.	Part Number	Rating	Description	
				Maker
IC101	NJM2203D			Dainichi
IC102	LA1235			Sanyo
IC103	HA12016			Hitachi
IC201	LA1245			Sanyo
IC301	TC9147P			Toshiba
IC302	TD6104P			"

Diodes

Item No.	Part Number	Rating	Description	
			Silicon	Maker
D101	1S2076-31		Silicon	Hitachi
D102	1S2076-31		"	"
D103	1S2076-31		"	"
D104	1S2076-31		"	"
D105	1S2076-31		"	"
D201	1S2076-31		"	"
D301	1S2076-31		"	"
D302	1S2076-31		"	"
D303	1S2076-31		"	"
D304	1S2076-31		"	"
D305	1S2076-31		"	"
D306	1S2076-31		"	"
D311	SLR-55DC5F		L.E.D.	Rohm
D312	SLR-55DC5F		"	"
D313	SLR-55DC5F		"	"
D314	SLR-55DC5F		"	"
D315	SLR-55DC5F		"	"
D316	SLR-55DC5F		"	"
D317	SLR-55DC5F		"	"
D318	SLR-55DC5F		"	"
VC101	1SV55		Varicap	Hitachi
VC102	1SV55		"	"
VC103	1SV55		"	"
VC104	1SV55		"	"
VC201	KV1226		"	Toko
VC202	KV1226		"	"

Coils

Item No.	Part Number	Rating	Description
L101	E03177-005		Balloon
L102	EQR2304-001		RF Coil
L103	EQR2304-002		"
L104	EQR2304-003		"
L105	EQR2304-002		"
L201	EQR1207-001		"
L202	EQL3001-102KY		Indicator
T101	EQT2121-001		FM. IFT
T102	EQT2140-003		I.F.TRANSF.
T103	EQF0102-001		Filter (for D)
T201	E03062-42		I.F.TRANSF.

Capacitors

Item No.	Part Number	Rating		Description
C102	QCS31HJ-680Z	68 pF	50 V	Ceramic
C103	QCF31HP-103Z	0.01 μ F	"	"
C104	QCS31HJ-5R0Z	5 pF	"	"
C105	QCS31HJ-4R0Z	4 pF	"	"
C106	QCS31HJ-5R0Z	5 pF	"	"
C107	QCS31HJ-4R0Z	4 pF	"	"
C108	QCF31HP-103Z	0.01 μ F	"	"
C109	QCS31HJ-330Z	33 pF	"	"
C110	QCF31HP-223Z	0.022 μ F	"	"
C111	QCF31HP-102Z	1000 pF	"	"
C112	QCS31HJ-1R0Z	1 pF	"	"
C113	QCS31HJ-100Z	10 pF	"	"
C113	QCS31HJ-100Z	"	"	"
C114	QCT25UJ-120Z	12 pF	"	"
C116	QCF31HP-223Z	0.022 μ F	"	"
C121	QCF31HP-223Z	"	"	"
C122	QCF31HP-223Z	"	"	"
C123	QCF31HP-223Z	"	"	"
C124	QCF31HP-223Z	"	"	"
C125	QCF31HP-223Z	"	"	"
C126	QCF31HP-223Z	"	"	"
C127	QCF31HP-223Z	"	"	"
C128	QET61HM-474Z	0.47 μ F	"	Electro
C129	QCS31HJ-121Z	120 pF	"	Ceramic (for A,B,C)
C129	QCS31HJ-330Z	33 pF	"	" (for D)
C130	QCF31HP-223Z	0.022 μ F	"	"

Capacitors

Item No.	Part Number	Rating		Description
C131	QET61HM-105Z	1 μ F	50 V	Electro
C132	QCF31HP-223Z	0.022 μ F	"	Ceramic
C133	QET61CM-107Z	100 μ F	16 V	Electro
C134	QCF31HP-223Z	0.022 μ F	50 V	Ceramic
C135	QET61CM-476Z	47 μ F	16 V	Electro
C136	QCF31HP-223Z	0.022 μ F	50 V	Ceramic
C137	QCF31HP-223Z	"	"	"
C138	QCF31HP-223Z	"	"	"
C139	QET61HM-475Z	4.7 μ F	"	Electro (for D)
C140	QET61HM-105Z	1 μ F	"	" (")
C141	QET61CM-226Z	22 μ F	16 V	" (")
C151	QET61CM-107Z	"	"	"
C152	QET61EM-106Z	10 μ F	25 V	"
C153	QFM31HJ-102Z	1000 pF	50 V	Mylar (for C, D)
C153	QFM31HJ-152Z	1500 pF	"	" (for A, B)
C154	QFM31HJ-102Z	1000 pF	"	" (for C, D)
C154	QFM31HJ-152Z	1500 pF	"	" (for A, B)
C155	QET61HM-475Z	4.7 μ F	"	Electro
C156	QET61HM-475Z	"	"	"
C157	QET61CM-226Z	22 μ F	16 V	"
C158	QET61CM-226Z	"	"	"
C159	QEB51EM-335	3.3 μ F	25 V	"
C160	QCF31HP-223Z	0.022 μ F	50 V	Ceramic
C161	QEB51HM-474	0.47 μ F	"	L.L.C.E.
C162	QET61EM-106Z	10 μ F	25 V	Electro
C163	QFP31HJ-102	1000 pF	50 V	"
C164	QFM31HK-473Z	0.047 μ F	"	Mylar
C165	QCS31HJ-151Z	150 pF	"	Ceramic
C202	QCY31HK-102Z	1000 pF	"	"
C203	QCF31HP-223Z	0.022 μ F	"	"
C204	QCF31HP-223Z	"	"	"
C205	QCF31HP-223Z	"	"	"
C206	QCF31HP-223Z	"	"	"
C207	QET61CM-226Z	22 μ F	16 V	Electro
C208	QCF31HP-223Z	0.022 μ F	50 V	Ceramic
C209	QCS31HJ-121Z	120 pF	"	"
C210	QCY31HK-102Z	1000 pF	"	"
C211	QFM31HK-103Z	0.01 μ F	"	Mylar
C212	QCF31HP-223Z	0.022 μ F	"	"
C213	QET61CM-476Z	47 μ F	16 V	Electro
C214	QET61HM-225Z	2.2 μ F	50 V	"
C215	QCF31HP-223Z	0.022 μ F	"	Ceramic
C216	QET61HM-105Z	1 μ F	"	Electro
C217	QET61HM-475Z	4.7 μ F	"	"
C218	QCS31HJ-271Z	220 pF	"	Ceramic
C219	QCS31HJ-181Z	180 pF	"	"
C220	QCT25UJ-150Z	15 pF	"	"
C221	QCF31HP-103Z	0.01 μ F	"	"
C222	QFM31HK-333Z	0.033 μ F	"	Mylar
C223	QFM31HK-823Z	0.082 μ F	"	"
C224	QCF31HP-223Z	0.022 μ F	"	Ceramic
C225	QCF31HP-223Z	"	"	"
C226	QCF31HP-223Z	"	"	"
C301	QCS31HJ-100Z	10 pF	"	"
C302	QCS31HJ-8R0Z	8 pF	"	"
C303	QET61HM-105Z	1 μ F	"	Electro
C304	QET61HM-105Z	"	"	"
C305	QCF31HP-223Z	0.022 μ F	"	Ceramic
C306	QCF31HP-223Z	"	"	"
C307	QET60JM-227Z	220 μ F	6.3 V	Electro
C308	QET50JM-228	2200 μ F	"	"
C309	QCF31HP-223Z	0.022 μ F	50 V	Ceramic
C310	QCF31HP-103Z	0.01 μ F	"	"
C311	QCF31HP-103Z	"	"	"
C312	QEZ0046-225	2.2 μ F	"	Nonflam
C313	QCY31HK-102Z	1000 pF	"	Ceramic
C314	QET61HM-226Z	22 μ F	"	Electro
C315	QET51CM-108	1000 μ F	16 V	"
C316	QCS31HJ-470Z	47 pF	50 V	Ceramic
C318	QCS31HJ-101Z	1000 pF	"	"
TC201	QAT2001-005			Trimmer
TC202	QAT2001-005			"

Resistors

Item No.	Part Number	Rating		Description
R101	QRD141J-473S	47 k	1/4 W	Carbon
R102	QRD141J-104S	100 k	"	"
R103	QRD141J-331S	330	"	"
R104	QRD141J-473S	47 k	"	"
R105	QRD141J-473S	"	"	"
R106	QRD141J-271S	270	"	"
R107	QRZ0052-820	82	"	Fusible Δ
R108	QRD141J-331S	330	"	Carbon
R109	QRD141J-124S	120 k	"	"
R110	QRD141J-124S	"	"	"
R111	QRD141J-562S	5.6 k	"	"
R112	QRD141J-103S	10 k	"	"
R113	QRD141J-221S	220	"	"
R121	QRZ0052-560	56	"	Fusible Δ
R122	QRD141J-331S	330	"	Carbon
R123	QRD141J-562S	5.6 k	"	"
R124	QRD141J-183S	18 k	"	"
R125	QRD141J-471S	470	"	"
R126	QRD141J-331S	330	"	"
R127	QRZ0052-560	56	"	Fusible Δ
R128	QRD141J-331S	330	"	Carbon
R129	QRD141J-562S	5.6 k	"	"
R130	QRD141J-153S	15 k	"	"
R131	QRD141J-221S	220	"	"
R132	QRD141J-331S	330	"	"
R133	QRD141J-331S	"	"	"
R134	QRD141J-103S	10 k	"	"
R135	QRD141J-561S	560	"	"
R136	QRD141J-183S	18 k	"	"
R137	QRD141J-332S	3.3 k	"	"
R138	QRZ0052-560	56	"	Fusible Δ
R139	QRD141J-333S	33 k	"	Carbon
R140	QRD141J-272S	2.7 k	"	"
R141	QRD141J-473S	47 k	"	"
R143	QRD141J-103S	10 k	"	" (for D)
R144	QRD141J-561S	560	"	" (")
R145	QRD141J-224S	220 k	"	" (")
R146	QRD141J-823S	82 k	"	" (")
R147	QRD141J-472S	4.7 k	"	" (")
R148	QRD141J-272S	2.7 k	"	" (")
R149	QRD141J-563S	56 k	"	"
R151	QRZ0052-560	56	"	Fusible Δ
R153	QRD141J-513S	51 k	"	Carbon
R154	QRD141J-513S	"	"	"
R155	QRD141J-332S	3.3 k	"	"
R156	QRD141J-332S	"	"	"
R157	QRD141J-472S	4.7 k	"	"
R158	QRD141J-472S	"	"	"
R159	QRD141J-183S	18 k	"	"
R160	QRD141J-183S	"	"	"
R161	QRD141J-682S	6.8 k	"	"
R162	QRD141J-682S	"	"	"
R163	QRD141J-102S	1 k	"	"
R164	QRD141J-682S	6.8 k	"	"
R165	QRD141J-224S	220 k	"	"
R166	QRD141J-103S	10 k	"	"
R201	QRD141J-103S	"	"	"
R202	QRD141J-152S	1.5 k	"	"
R203	QRD141J-271S	270	"	"
R204	QRD141J-222S	2.2 k	"	"
R205	QRD141J-331S	330	"	"
R206	QRD141J-101S	100	"	"
R207	QRD141J-103S	10 k	"	"
R208	QRD141J-103S	"	"	"
R209	QRD141J-820S	82	"	"
R210	QRZ0052-560	56	"	Fusible Δ
R211	QRD141J-223S	2.2 k	"	Carbon
R212	QRD141J-153S	15 k	"	"
R213	QRD141J-473S	47 k	"	"
R214	QRD141J-103S	10 k	"	"
R215	QRD141J-472S	4.7 k	"	"
R301	QRD141J-682S	6.8 k	"	"

Resistors

Item No.	Part Number	Rating		Description
R302	QRD141J-332S	3.3 k	1/4 W	Carbon
R303	QRD141J-682S	6.8 k	"	"
R304	QRD141J-332S	3.3 k	"	"
R305	QRD141J-682S	6.8 k	"	"
R306	QRD141J-332S	3.3 k	"	"
R307	QRD141J-682S	6.8 k	"	"
R308	QRD141J-332S	3.3 k	"	"
R309	QRD141J-472S	4.7 k	"	"
R310	QRD141J-472S	"	"	"
R311	QRD141J-683S	68 k	"	"
R312	QRD141J-683S	"	"	"
R313	QRD141J-104S	100 k	"	"
R314	QRD141J-102S	1 k	"	"
R315	QRD141J-121S	120	"	"
R316	QRD141J-560S	56	"	"
R317	QRD141J-104S	100 k	"	"
R318	QRD141J-102S	1 k	"	"
R319	QRD141J-272S	2.7 k	"	"
R320	QRD141J-123S	12 k	"	"
R321	QRD141J-152S	1.5 k	"	"
R322	QRD141J-331S	330	"	"
R323	QRD141J-271S	270	"	"
R324	QRD141J-822S	8.2 k	"	"
R325	QRD141J-103S	10 k	"	"
R326	QRD141J-103S	"	"	"
R327	QRD141J-102S	1 k	"	"
R328	QRD141J-332S	3.3 k	"	"
R329	QRD141J-332S	"	"	"
R337	QRD141J-223S	22 k	"	"
R339	QRD141J-105S	1 M	"	"
VR101	QVP4A0B-103	10 k (B)	0.1 W	Variable
VR102	QVP4A0B-104	100 k(B)	"	"
VR103	QVP4A0B-222	2.2k(B)	"	"

Others

Item No.	Part Number	Rating	Description
	E03572-021		Antenna Terminal (for A, B, C)
	EMB01YV-401A		" (for D)
	E67764-002		Terminal Assy
	E10739-001		Circuit Board
P101	QMV5005-010		10P Plug Assy
P102	QMV5005-004		4P Plug Assy
P201	QMV5005-004		"
P301	E04365-005		F.W. Socket
P302	E04365-003		3P Socket
P303	E04365-007		F.W. Socket
P304	E04365-006		6P Connector
T105	E03427-020		L.P. Filter
T106	E03427-020		"
CF101	ECB2123-003 (R)		C. Filter
CF102	ECB2123-003 (R)		"
CF103	ECB2123-003 (R)		"
CF201	ECB1117-001		"
CF202	E03613-022		"
SW301	ESP0001-007		Push Switch
SW302	ESP0001-007		"
SW303	ESP0001-007		"
SW304	ESP0001-007		"
SW305	ESP0001-007		"
SW306	ESP0001-007		"
SW307	ESP0001-007		"
SW308	ESP0001-007		"
SW309	ESP0001-007		"
SW310	ESP0001-007		"
SW311	ESP0001-007		"
SW312	QSS2201-004		Slide Switch (for A, B)
XT301	ECX0007-200KA		Resonator

8-(2) TXX-402 □ Power Amp P.C. Board Ass'y

Note: TXX-402 □-1 varies according to the areas employed. See note (1).

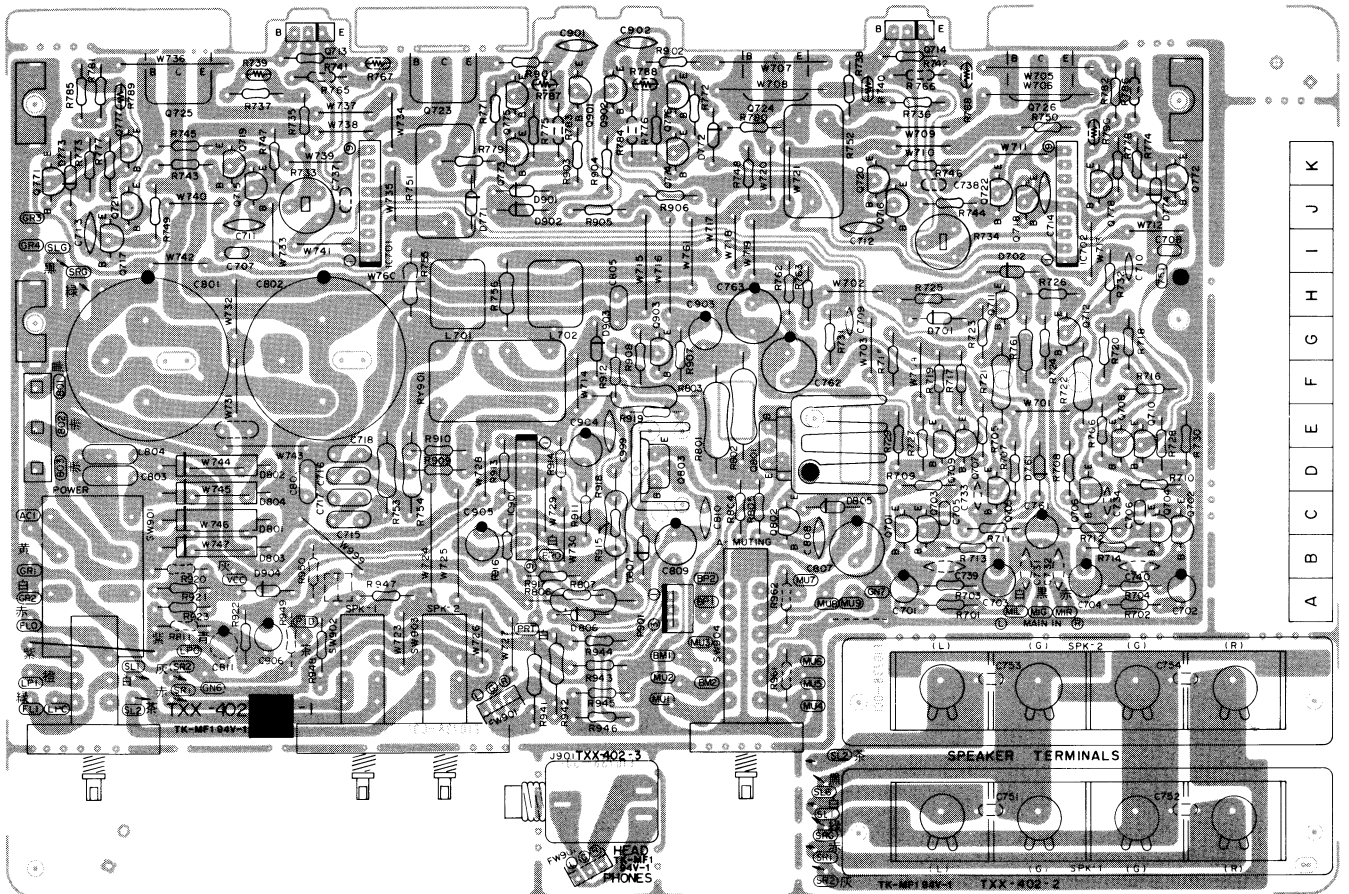

Fig. 15

Each Individual P.C. Board Location

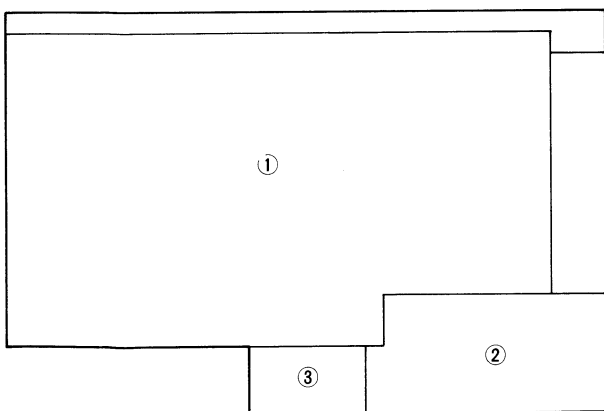

Fig. 16

- ① TXX-402-1 Power Amp. P.C. Board Ass'y
- ② TXX-402-2 Speaker Terminal P.C. Board Ass'y
- ③ TXX-402-3 Headphone Jack P.C. Board Ass'y

Note (1)

Designated Areas	P.C. Board Ass'y
U.S.A., Canada, U.S. Military Market & Other Countries	TXX-402 G
U.K., Australia, & Europe	TXX-402 H
West Germany	TXX-402 I

Note (2)

The symbols (赤, 黒, 白 . . . etc) on P.C. Board surface are factory process only.

Transistors

Item No.	Part Number	Rating	Description	
				Maker
Q701	2SC2240 (BL2)		Silicon	Toshiba
Q702	2SC2240 (BL2)		"	"
Q703	2SC2240 (BL2)		"	"
Q704	2SC2240 (BL2)		"	"
Q705	2SA1084 (D, E)		"	"
Q706	2SA1084 (D, E)		"	"
Q707	2SA1084 (D, E)		"	"
Q708	2SA1084 (D, E)		"	"
Q709	2SA1084 (D, E)		"	"
Q710	2SA1084 (D, E)		"	"
Q711	2SC2546 (E, F)		"	"
Q712	2SC2546 (E, F)		"	"
Q713	2SD636 (Q, R)		"	"
Q714	2SD636 (Q, R)		"	Matsushita
Q715	2SC1775AV (F)		"	Hitachi
Q716	2SC1775AV (F)		"	"
Q717	2SA872AV (E)		"	"
Q718	2SA872AV (E)		"	"
Q719	2SC2235 (O, Y)		"	Toshiba
Q720	2SC2235 (O, Y)		"	"
Q721	2SA965 (O, Y)		"	"
Q722	2SA965 (O, Y)		"	"
Q723	2SD845LB (R, O)		"	"
Q724	2SD845LB (R, O)		"	"
Q725	2SB755LB (R, O)		"	"
Q726	2SB755LB (R, O)		"	"
Q771	2SC945A (P, Q)		"	NEC
Q772	2SC945A (P, Q)		"	"
Q773	2SC945A (P, Q)		"	"
Q774	2SC945A (P, Q)		"	"
Q775	2SA733A (P, Q)		"	"
Q776	2SA733A (P, Q)		"	"
Q777	2SA733A (P, Q)		"	"
Q778	2SA733A (P, Q)		"	"
Q801	2SD313V (D, E)		"	Toshiba
Q802	2SC945A (P, Q)		"	NEC
Q803	2SB507V (D, E)		"	Sanyo
Q901	2SC1775AV (F)		"	Hitachi
Q902	2SC1775AV (F)		"	"
Q903	2SA872AV (E)		"	"

Integrated Circuits

Item No.	Part Number	Rating	Description	
				Maker
IC701	VC5022 (X, Y)			Toyodengu
IC702	VC5022 (X, Y)			"
IC901	TA7317P			Toshiba

Diodes

Item No.	Part Number	Rating	Description	
				Maker
D701	1S2076-31		Silicon	Hitachi
D702	1S2076-31		"	"
D761	RD9.1EB3		"	NEC
D771	1S2076-31		"	Hitachi
D772	1S2076-31		"	"
D773	1S2076-31		"	"
D774	1S2076-31		"	"
D801	S3V20F		"△	Shindengen
D802	S3V20F		"△	"
D803	S3V20F		"△	"

Diodes

Item No.	Part Number	Rating	Description	
				Maker
D804	S3V20F		Silicon△	Shindengen
D805	RD16EB3		"	NEC
D806	RD16EB3		"	"
D807	1S2076-31		"	Hitachi
D901	1S2076-31		"	"
D902	1S2076-31		"	"
D903	1S2076-31		"	"
D904	1S2076-31		"	"
D999	1S2076-31		"	"

Coils

Item No.	Part Number	Rating	Description
L701	EQL0101-1R2		Inductor
L702	EQL0101-1R2		"

Capacitors

Item No.	Part Number	Rating		Description
C701	QET51HM-475	4.7 μF	50 V	Electro
C702	QET51HM-475	"	"	"
C703	QET51AM-476	47 μF	10 V	"
C704	QET51AM-476	"	"	"
C705	QFM81HK-272	2700 pF	50 V	Mylar
C706	QFM81HK-272	"	"	"
C707	QFM81KH-332	3300 pF	"	"
C708	QFM81HK-332	"	"	"
C709	QCS21HJ-7R0A	7 pF	"	Ceramic
C710	QCS21HJ-7R0A	"	"	"
C711	QCS22HJ-470	47 pF	500 V	"
C712	QCS22HJ-470	"	"	"
C713	QCS22JH-470	"	"	"
C714	QCS22HJ-470	"	"	"
C715	QFM81HK-473	0.047 μF	"	Mylar
C716	QFM81HK-473	"	"	"
C717	QFM81HK-473	"	"	"
C718	QFM81HK-473	"	"	"
C751	QFM81HK-102	0.001 μF	"	"
C752	QFM81HK-102	"	"	"
C753	QFM81HK-102	"	"	"
C754	QFM81HK-102	"	"	"
C761	QET51EM-106	10 μF	25 V	Electro
C762	QET61HM-107Z	100 μF	50 V	"
C763	QET61HM-107Z	"	"	"
C801	QEW81HA-878	8700 μF	56 V	"
C802	QEW81HA-878	"	"	"
C803	QCE22HP-103	0.01 μF	500 V	Ceramic △
C804	QFH42EM-104	0.1 μF	250 V	"
C805	QFM32AK-473Z	0.047 μF	10 V	Mylar
C806	QFM32AK-473Z	"	"	"
C807	QET51EM-227	220 μF	25 V	Electro
C808	QCF21HP-103A	0.01 μF	50 V	Ceramic
C809	QET51EM-107	100 μF	25 V	Electro
C810	QCF21HP-103A	0.01 μF	50 V	Ceramic
C811	QET61HM-105Z	1 μF	"	Electro
C901	QCF21HP-223A	0.022 μF	"	"
C902	QCF21HP-223A	"	"	"
C903	QET51HM-226	22 μF	"	Electro
C904	QET51AM-107	100 μF	10 V	"
C905	QET51CM-226	22 μF	16 V	"
C906	QET51HM-105	1 μF	50 V	"
C998	QEZ0046-105	"	"	Nonpole
C999	QCF21HP-102A	1000 pF	"	Ceramic

Resistors

Item No.	Part Number	Rating		Description
R701	QRD141J-222S	2.2 k	1/4 W	Carbon
R702	QRD141J-222S	"	"	"
R703	QRD141J-473S	47 k	"	"
R704	QRD141J-473S	"	"	"
R705	QRD149J-202S	2 k	"	U. Carbon △
R706	QRD149J-202S	2 k	"	" △
R707	QRD149J-202S	2 k	"	" △
R708	QRD149J-202S	2 k	"	" △
R709	QRD141J-101S	100	"	Carbon
R710	QRD141J-101S	"	"	"
R711	QRD141J-472S	4.7 k	"	"
R712	QRD141J-472S	"	"	"
R713	QRD141J-272S	2.7 k	"	"
R714	QRD141J-272S	"	"	"
R715	QRD149J-101S	100	"	U. Carbon △
R716	QRD149J-101S	"	"	" △
R717	QRD149J-390S	39	"	" △
R718	QRD149J-390S	"	"	" △
R719	QRD149J-390S	"	"	" △
R720	QRD149J-390S	"	"	" △
R721	QRG017J-822S	8.2 k	1 W	O.M. Film △
R722	QRG017J-822S	"	"	" △
R723	QRD149J-271S	270	1/4 W	U. Carbon △
R724	QRD149J-271S	"	"	" △
R725	QRD149J-271S	"	"	" △
R726	QRD149J-271S	"	"	" △
R727	QRD141J-152S	1.5 k	"	Carbon
R728	QRD141J-152S	"	"	"
R729	QRD141J-433S	43 k	"	"
R730	QRD141J-433S	"	"	"
R731	QRD141J-473S	47 k	"	"
R732	QRD141J-473S	"	"	"
R733	QVP4A0B-471	470	0.1 W	Variable
R734	QVP4A0B-471	"	"	"
R735	QRD141J-431S	430	1/4 W	Carbon
R736	QRD141J-431S	"	"	"
R737	QRD141J-561S	560	"	"
R738	QRD141J-561S	"	"	"
R741	QRD141J-431S	430	"	"
R742	QRD141J-431S	"	"	"
R743	QRD149J-272S	2.7 k	"	U. Carbon △
R744	QRD149J-272S	"	"	" △
R745	QRD149J-271S	270	"	" △
R746	QRD149J-271S	"	"	" △
R747	QRD149J-100S	10	"	" △
R748	QRD149J-100S	"	"	" △
R749	QRD149J-100S	"	"	" △
R750	QRD149J-100S	"	"	" △
R751	ERF032K-R22	0.22	3 W	Cement
R752	ERF032K-R22	"	"	"
R753	QRX017J-100S	10	1 W	O.M. Film △
R754	QRX017J-100S	"	"	" △
R755	QRD129J-330	33	1/2 W	U. Carbon △
R756	QRD129J-330	"	"	" △
R761	QRD129J-562	5.6 k	"	" △
R762	QRD149J-220S	22	1/4 W	" △
R763	QRD149J-220S	"	"	" △
R767	ERT-D2WFL351S	"	"	"
R768	ERT-D2WFL351S	"	"	"
R771	QRD141J-103S	10 k	"	Carbon
R772	QRD141J-103S	"	"	"
R773	QRD141J-103S	"	"	"
R774	QRD141J-103S	10 k	"	"
R775	QRD141J-102S	1 k	"	"
R776	QRD141J-102S	"	"	"
R777	QRD141J-102S	"	"	"
R778	QRD141J-102S	"	"	"

Resistors

Item No.	Part Number	Rating		Description
R779	QRD141J-132S	1.3 k	1/4 W	Carbon
R780	QRD141J-132S	"	"	"
R781	QRD141J-132S	"	"	"
R782	QRD141J-132S	"	"	"
R783	QRD141J-103S	10 k	"	"
R784	QRD141J-103S	"	"	"
R785	QRD141J-103S	"	"	"
R786	QRD141J-103S	"	"	"
R787	ERT-D2WL351S	"	"	"
R788	ERT-D2WL351S	"	"	"
R801	QRG027J-221	220	2 W	O.M. Film △
R802	QRG027J-221	"	"	" △
R803	QRG027J-221	"	"	" △
R804	QRD149J-101S	100	1/4 W	U. Carbon △
R805	QRD141J-332S	3.3 k	"	Carbon
R806	QRG027J-181	180	2 W	O.M. Film △
R807	QRD141J-392S	3.9 k	1/4 W	Carbon
R811	QRD141J-223S	22 k	"	"
R901	QRD141J-681S	680	"	"
R902	QRD141J-681S	"	"	"
R903	QRD141J-562S	5.6 k	"	"
R904	QRD141J-562S	"	"	"
R905	QRD141J-123S	12 k	"	"
R906	QRD141J-123S	"	"	"
R907	QRD141J-103S	10 k	"	"
R908	QRD141J-332S	3.3 k	"	"
R909	QRD141J-104S	100 k	"	"
R910	QRD141J-104S	"	"	"
R911	QRD141J-104S	"	"	"
R912	QRD141J-563S	56 k	"	"
R913	QRD141J-563S	"	"	"
R914	QRD141J-183S	18 k	"	"
R915	QRD141J-683S	68 k	"	"
R916	QRD141J-153S	15 k	"	"
R917	QRD141J-204S	200 k	"	"
R918	QRG027J-102	1 k	2 W	O.M. Film △
R919	QRD141J-390S	39	1/4 W	Carbon
R921	QRD141J-472S	4.7 k	"	"
R922	QRD141J-223S	22 k	"	"
R923	QRD141J-102S	1 k	"	"
R941	QRG017J-221S	220	1 W	O.M. Film △
R942	QRG017J-221S	"	"	" △
R943	QRD141J-332S	3.3 k	1/4 W	Carbon
R944	QRD141J-332S	"	"	"
R945	QRD141J-681S	680	"	"
R946	QRD141J-681S	"	"	"
R947	QRD141J-222S	2.2 k	"	"
R948	QRD141J-222S	"	"	"
R961	QRD141J-104S	100 k	"	"
R962	QRD141J-104S	100 k	"	"

Others

Item No.	Part Number	Rating	Description
	E03572-007EM		Speaker Terminal
	E67764-103		W. Terminal
	E302267-002		Heat Sink
	SBSB3008Z		Screw
	SBSE3012Z		"
	E60171-003		Heat Sink
	E65396-001		earth Plate
J901	QMS6302-116		Headphone Jack
P901	QMV5005-003		3P Plug Assy
(L)	E302256-001		H. Sink Bracket
(R)	E302256-002		"
RY901	ESK6D24-213		Relay
SW901	QSP0020-003		Push Switch △
SW901	QSP0020-004		(for G) Power Push Switch △
SW901	QSP0020-004		(for H, I) Power
SW902	QSP0229-059		"
SW903	QSP0229-059		" (Speaker)
SW904	QSP0219-058		" (Audio Muting)

8-(3) TDC-65 □ Display P.C. Board Ass'y

Note: TDC-65 □-1 varies according to the areas employed. See note (1).

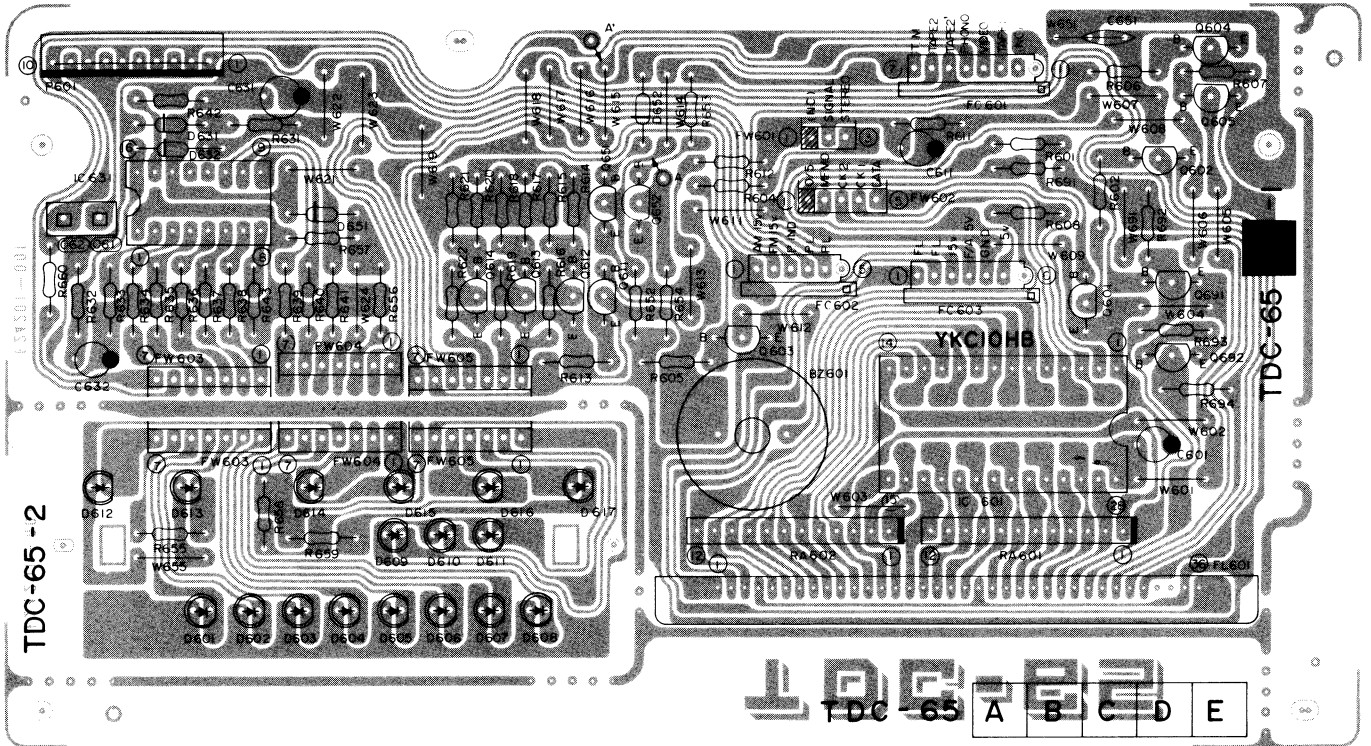

Fig. 17

Note (1)

Designated Areas	P.C. Board Ass'y
U.S.A. & Canada	TDC-65A
All other areas	TDC-65B

Note (2)

The symbols (赤, 黒, 白 . . . etc) on P.C. Board surface are factory process only.

Transistors

Item No.	Part Number	Rating	Description	
				Maker
Q601	2SC458 (C, D)		Silicon	Hitachi
Q602	2SA1029 (C, D)		"	"
Q603	2SA1029 (C, D)		"	"
Q604	2SC458 (C, D)		"	"
Q605	2SA1029 (C, D)		"	"
Q611	2SA1029 (D)		"	"
Q612	2SC458 (D)		"	"
Q613	2SC458 (D)		"	"
Q614	2SC458 (D)		"	"
Q651	2SC458 (C, D)		"	"
Q652	2SC458 (C, D)		"	"
Q691	2SC458 (C, D)		"	"
Q692	2SC458 (C, D)		"	"

Integrated Circuit

Item No.	Part Number	Rating	Description	
				Maker
IC601	TD6301AP			Toshiba
IC631	TA7612AP			"

Diodes

Item No.	Part Number	Rating	Description	
				Maker
D601	TL0143		L.E.D.	Toshiba
D602	TL0143		"	"
D603	TL0143		"	"
D604	TL0143		"	"
D605	TL0143		"	"
D606	TL0143		"	"
D607	TL0143		"	"
D608	TL0143		"	"
D609	TLG143 (E, F)		"	"
D610	TLG143 (")		"	"
D611	TLG143 (")		"	"
D612	TLR143		"	"
D613	TLR143		"	"
D614	TL0143		"	"
D615	TL0143		"	"
D616	TL0143		"	"
D617	TL0143		"	"
D631	1S2076-31		Silicon	Hitachi
D632	1S2076-31		"	"
D651	RD5.1EB2		"	"
D652	1S2076-31		"	"

Capacitors

Item No.	Part Number	Rating		Description
		Value	Voltage	
C611	QET61CM-226Z	22 μ F	16 V	Electroly
C631	QET61CM-476Z	47 μ F	"	"
C632	QET61HM-475Z	4.7 μ F	"	"
C652	QCS31HJ-331Z	330 pF	50 V	Ceramic
C653	QCS31HJ-331Z	"	"	"

Resistors

Item No.	Part Number	Rating		Description
		Value	Power	
R601	QRD141J-563S	56 k	1/4 W	Carbon
R602	QRD141J-563S	"	"	"
R604	QRD141J-563S	"	"	"
R605	QRD141J-103S	10 k	"	"
R606	QRD141J-563S	56 k	"	"
R607	QRD141J-563S	"	"	"
R608	QRD141J-103S	10 k	"	"
R611	QRD141J-562S	5.6 k	"	"
R612	QRD141J-562S	"	"	"
R613	QRD141J-392S	3.9 k	"	"
R614	QRD141J-182S	1.8 k	"	"
R615	QRD141J-102S	1 k	"	"
R616	QRD141J-102S	"	"	"
R617	QRD141J-222S	2.2 k	"	"
R618	QRD141J-102S	1 k	"	"
R619	QRD141J-102S	"	"	"
R620	QRD141J-272S	2.7 k	"	"
R621	QRD141J-102S	1 k	"	"
R622	QRD141J-102S	"	"	"
R630	QRZ0052-220	22	"	Fusible Δ
R631	QRD141J-390S	39	"	Carbon
R632	QRD141J-273S	27	"	"
R633	QRD141J-511S	510	"	"
R634	QRD141J-122S	1.2 k	"	"
R635	QRD141J-122S	"	"	"
R636	QRD141J-122S	"	"	"
R637	QRD141J-122S	"	"	"

Resistors

Item No.	Part Number	Rating		Description
		Value	Power	
R638	QRD141J-122S	1.2 k	1/4 W	Carbon
R639	QRD141J-122S	"	"	"
R640	QRD141J-122S	"	"	"
R641	QRD141J-122S	"	"	"
R642	QRD141J-124S	120 k	"	"
R643	QRD141J-103S	10 k	"	"
R651	QRD141J-563S	56 k	"	"
R652	QRD141J-104S	100 k	"	"
R653	QRD141J-103S	101 k	"	"
R655	QRD141J-681S	680 k	"	"
R656	QRD129J-152	1.5 k	1/2 W	U. Carbon Δ
R657	QRD141J-562S	5.6 k	1/4 W	Carbon
R658	QRD141J-102S	1 k	"	"
R659	QRD141J-102S	1 k	"	"
R660	QRD129J-152	1.5 k	1/2 W	U. Carbon Δ
R691	QRD141J-563S	56 k	"	Carbon
R692	QRD141J-222S	2.2 k	"	"
R693	QRD141J-563S	56 k	"	"
R694	QRD141J-472S	4.7 k	"	"

Others

Item No.	Part Number	Rating	Description
P601	E67764-002		Terminal Assy
	E24201-001		Cir Board
	QMV5005-010		10P Plug Assy
BZ601	ENZ7001-001		CE. Buzzer
FC601	E04365-007		F.W. Socket
FC602	E04365-005		"
FC603	E04365-006		6P Connector
RA601	ERGSBXX-472		Resistor Array
RA602	ERGSBXX-472		"
FL601	ELU0001-011		Fluorescent Lamp
	E302266-001		LED Holder

8-(4) TAC-532A SEA Control P.C. Board Ass'y

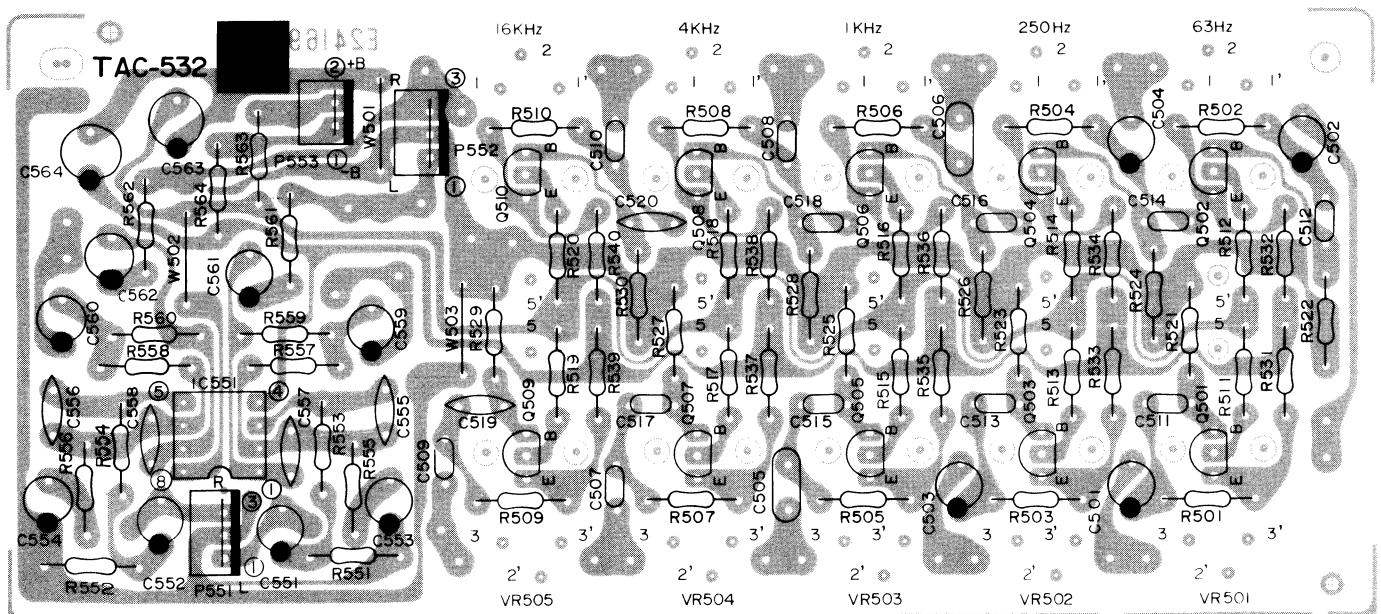

Fig. 18

Transistors

Item No.	Part Number	Rating		Description	
				Material	Maker
Q501	2SC1775AV(F)			Silicon	Hitachi
Q502	2SC1775AV(F)			"	"
Q503	2SC1775AV(F)			"	"
Q504	2SC1775AV(F)			"	" (for B)
Q505	2SC1775AV(F)			"	Hitachi
Q506	2SC1775AV(F)			"	"
Q507	2SC1775AV(F)			"	"
Q508	2SC1775AV(F)			"	"
Q509	2SC1775AV(F)			"	"
Q510	2SC1775AV(F)			"	"

Integrated Circuit

Item No.	Part Number	Rating		Description	
				Category	Maker
IC551	NJM4560D-X			I.C.	Dainichi

Capacitors

Item No.	Part Number	Rating		Description
		Value	Voltage	
C501	QET51HM-225	2.2 μ F	50 V	Electro
C502	QET51HM-225	"	"	"
C503	QET51HM-474	0.47 μ F	"	"
C504	QET51HM-474	"	"	"
C505	QFM81HK-124	0.12 μ F	"	Mylar
C506	QFM81HK-124	"	"	"
C507	QFM81HK-273	0.027 μ F	"	"
C508	QFM81HK-273	"	"	"
C509	QFM81HK-682	6800 pF	"	"
C510	QFM81HK-682	"	"	"
C511	QFM81HK-223	0.022 μ F	"	"
C512	QFM81HK-223	"	"	"
C513	QFM81HK-822	8200 pF	"	"
C514	QFM81HK-822	"	"	"
C515	QFM81HK-332	3300 pF	"	"
C516	QFM81HK-332	"	"	"
C517	QFM81HK-122	1200 pF	"	"
C518	QFM81HK-122	"	"	"
C519	QCS21HJ-561A	560 pF	"	Ceramic
C520	QCS21HJ-561A	"	"	"
C551	QET51HM-475	4.7 μ F	"	Electro
C552	QET51HM-475	"	"	"
C553	QET51AM-476	47 μ F	10 V	"
C554	QET51AM-476	"	"	"
C555	QCS21HJ-101	100 pF	50 V	Ceramic
C556	QCS21HJ-101	"	"	"
C557	QCS31HJ-330Z	33	"	"
C558	QCS31HJ-330Z	"	"	"
C559	QET51AM-476	47 μ F	10 V	Electro
C560	QET51AM-476	"	"	"
C561	QET51HM-475	4.7 μ F	50 V	"
C562	QET51HM-475	"	"	"

Resistors

Item No.	Part Number	Rating		Description
		Value	Power	
R501	QRD141J-122S	1.2 k	1/4 W	Carbon
R502	QRD141J-122S	"	"	"
R503	QRD141J-122S	"	"	"
R504	QRD141J-122S	"	"	"
R505	QRD141J-122S	"	"	"
R506	QRD141J-122S	"	"	"
R507	QRD141J-122S	"	"	"
R508	QRD141J-122S	"	"	"
R509	QRD141J-122S	"	"	"
R510	QRD141J-122S	"	"	"
R511	QRD141J-391S	390	"	"
R512	QRD141J-391S	"	"	"
R513	QRD141J-391S	"	"	"
R514	QRD141J-391S	"	"	"
R515	QRD141J-391S	"	"	"

Resistors

Item No.	Part Number	Rating		Description
		Value	Power	
R516	QRD141J-391S	390	1/4 W	Carbon
R517	QRD141J-391S	"	"	"
R518	QRD141J-391S	"	"	"
R519	QRD141J-391S	"	"	"
R520	QRD141J-391S	"	"	"
R521	QRD141J-124S	120 k	"	"
R522	QRD141J-124S	"	"	"
R523	QRD141J-913S	91 k	"	"
R524	QRD141J-913S	"	"	"
R525	QRD141J-513S	51 k	"	"
R526	QRD141J-513S	"	"	"
R527	QRD141J-393S	39 k	"	"
R528	QRD141J-393S	"	"	"
R529	QRD141J-223S	22 k	"	"
R530	QRD141J-223S	"	"	"
R531	QRD141J-472S	4.7 k	"	"
R532	QRD141J-472S	"	"	"
R533	QRD141J-472S	"	"	"
R534	QRD141J-472S	"	"	"
R535	QRD141J-472S	"	"	"
R536	QRD141J-472S	"	"	"
R537	QRD141J-472S	"	"	"
R538	QRD141J-472S	"	"	"
R539	QRD141J-472S	"	"	"
R540	QRD141J-472S	"	"	"
R551	QRD141J-184S	180 k	"	"
R552	QRD141J-184S	"	"	"
R553	QRD141J-102S	1 k	"	"
R554	QRD141J-102S	"	"	"
R555	QRD141J-472S	4.7 k	"	"
R556	QRD141J-472S	"	"	"
R557	QRD141J-273S	27 k	"	"
R558	QRD141J-273S	"	"	"
R559	QRD141J-562S	5.6 k	"	"
R560	QRD141J-562S	"	"	"
R561	QRD141J-562S	"	"	"
R562	QRD141J-562S	"	"	"
R563	QRD149J-100S	10	"	" \triangle
R564	QRD149J-100S	"	"	" \triangle
VR501	QVZ5010-105	100 k	"	S. Variable
VR502	QVZ5010-105	"	"	"
VR503	QVZ5010-105	"	"	"
VR504	QVZ5010-105	"	"	"
VR505	QVZ5010-105	"	"	"

Others

Item No.	Part Number	Rating	Description
	QMV5005-002		2P Plug Assy
	QMV5005-003		3P Plug Assy
	E24169-001		Circuit Board

8-(5) TXX-403 □ Pre Amp P.C. Board Ass'y

Note: TXX-403 □-1 varies according to the areas employed. See note (1).

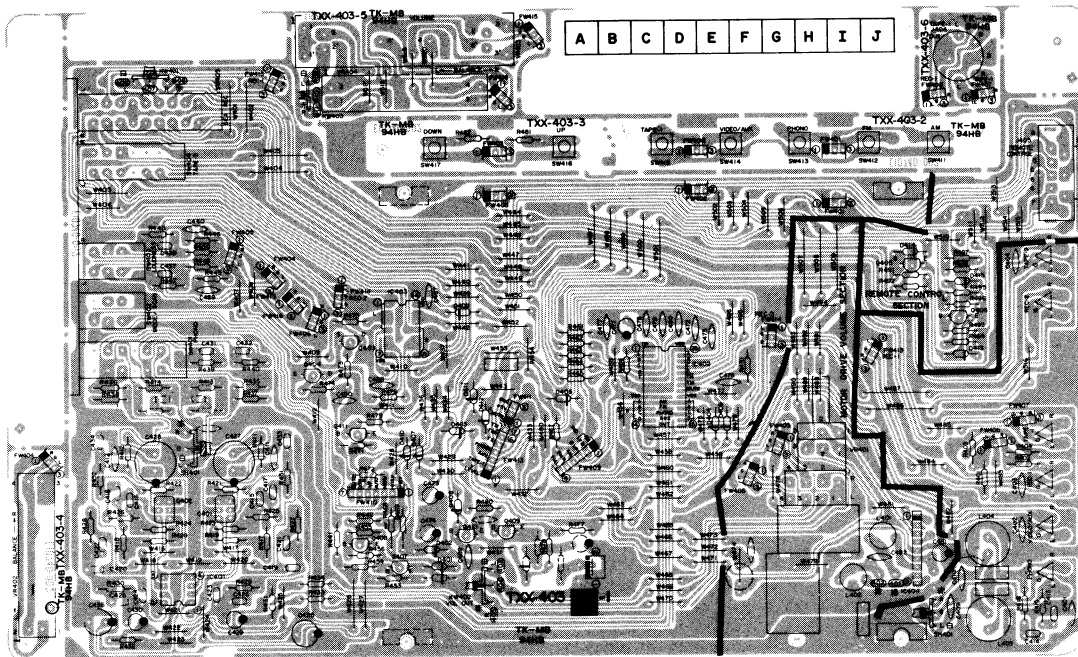

Fig. 19

Each Individual P.C. Board Location

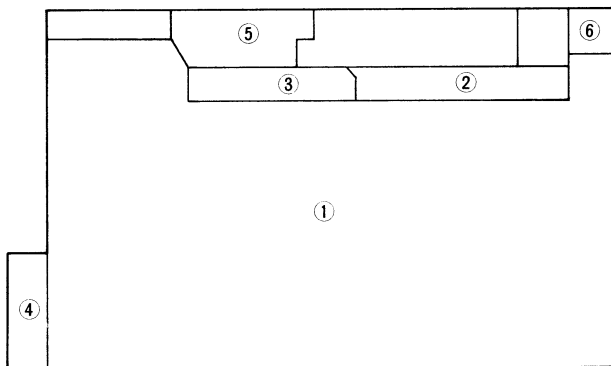

Fig. 20

- ① TXX-403-1 Pin Jack, Equalizer Amp., Mode Switch Analog Switch P. C. Board Ass'y
- ② TXX-403-2 Source Select Switch P.C. Board Ass'y
- ③ TXX-403-3 Volume Control Switch P.C. Board Ass'y
- ④ TXX-403-4 Balance Volume P.C. Board Ass'y
- ⑥ TXX-403-6 DIN Socket P.C. Board Ass'y

Note (2)

The symbols (赤, 黒, 白 etc) on P.C. Board surface are factory process only.

Transistors

Item No.	Part Number	Rating	Description	
				Maker
Q401	2SK240 (BL, V)		F.E.T.	Toshiba
Q402	2SK240 (BL, V)		"	"
Q403	2SK163 (K2)		"	NEC
Q404	2SK163 (K2)		"	"
Q407	2SA733A (P, Q)		Silicon	NEC
Q408	2SA733A (P, Q)		"	"
Q409	2SC945A (P, Q)		"	"
Q410	2SC945A (P, Q)		"	"
Q411	2SA733A (P, Q)		"	"

Note (1)

Designated Areas	P.C. Board Ass'y
U.S.A., Canada, U.S. Military Market & Other Countries	TXX-403 D
U.K., Australia & Europe	TXX-403 E
West Germany	TXX-403 F

Integrated Circuits

Item No.	Part Number	Rating	Description	
				Maker
IC401	NJM4560D-X			Dainichi
IC402	LC7815H			Sanyo
IC403	LC4066BH			"

Diodes

Item No.	Part Number	Rating	Description	
				Maker
D401	RD12EB3		Silicon	NEC
D402	RD5.6EB3		"	"
D403	1S2076-31		"	Hitachi
D404	1S2076-31		"	"
D405	1S2076-31		"	"
D406	1S2076-31		"	"
D407	1S2076-31		"	"
D408	1S2076-31		"	"
D409	1S2076-31		"	"
D410	1S2076-31		"	"
D411	1S2076-31		"	"
D412	1S2076-31		"	"
D413	1S2076-31		"	"
D431	1S2076-31		"	"
D432	RD5.6EB3		"	NEC
D435	1S2076-31		"	Hitachi

Coils

Item No.	Part Number	Rating	Description
L401	EQL0111-151		Inductor

Capacitors

Item No.	Part Number	Rating		Description
C401	QCF31HP-223Z	0.022 μ F	50 V	Ceramic
C402	QCF31HP-223Z	"	"	"
C403	QCF31HP-223Z	"	"	"
C404	QCF31HP-223Z	"	"	"
C409	QCS31HJ-471Z	470 P	"	" (for F)
C410	QCS31HJ-471Z	"	"	" (")
C411	QCS31HJ-270Z	27 pF	"	"
C412	QCS31HJ-270Z	"	"	"
C413	QFP31HJ-151	150 pF	"	Poly
C414	QFP31HJ-151	"	"	"
C415	QFM31HK-392Z	3900 pF	"	Mylar
C416	QFM31HK-392Z	"	"	"
C417	QFM31HK-822Z	8200 pF	"	"
C418	QFM31HK-822Z	"	"	"
C419	QFM31HJ-822Z	"	"	"
C420	QFM31HJ-822Z	"	"	"
C421	QFM31HJ-273Z	0.027 μ F	"	"
C422	QFM31HJ-273Z	"	"	"
C423	QFM31HJ-682Z	6800 pF	"	"
C424	QFM31HJ-682Z	"	"	"
C425	QFM31HJ-322Z	3300 pF	"	"
C426	QFM31HJ-332Z	"	"	"
C427	QET60JM-227Z	220 μ F	6.3 V	Electro
C428	QET60JM-227Z	"	"	"
C429	QET61HM-475Z	4.7 μ F	50 V	"
C430	QET61HM-475Z	"	"	"
C433	QFM31HK-473Z	0.047 μ F	"	"
C434	QFM31HK-473Z	"	"	"
C435	QET61CM-107Z	100 μ F	16 V	Electro
C436	QET61CM-107Z	"	"	"
C437	QFM31HK-183Z	0.018 μ F	50 V	Mylar
C438	QFM31HK-183Z	"	"	"
C439	QCS31HJ-181Z	180 pF	"	Ceramic
C440	QCS31HJ-181Z	180 pF	"	"
C471	QET61HM-475Z	4.7 μ F	"	Electro
C472	QCY31HK-102Z	1000 pF	"	Ceramic
C473	QET61CM-226Z	22 μ F	16 V	Electro
C474	QET61CM-226Z	"	"	"
C475	QCF31HP-223Z	0.022 μ F	50 V	Ceramic
C476	QCF31HP-223Z	"	"	"
C477	QCS31HJ-101Z	100 pF	"	"
C478	QCS31HJ-101Z	"	"	"
C479	QCS31HJ-101Z	"	"	"
C480	QCS31HJ-101Z	"	"	"
C483	QCF31HP-223Z	"	"	"
C484	QCF31HP-223Z	"	"	"
C487	QCF31HP-223Z	"	"	"
C488	QCF31HP-223Z	"	"	"
C489	QCF31HP-223Z	"	"	"
C490	QCF31HP-223Z	"	"	"

Resistors

Item No.	Part Number	Rating		Description
R420	QRD141J-362S	3.6 k	1/4 W	Carbon
R421	QRD141J-332S	3.3 k	"	"
R422	QRD141J-332S	"	"	"
R423	QRD141J-270S	27	"	"
R424	QRD141J-270S	"	"	"
R425	QRD141J-561S	560	"	"
R426	QRD141J-561S	"	"	"
R427	QRD141J-913S	91 k	"	"
R428	QRD141J-913S	"	"	"
R429	QRD141J-752S	7.5 k	"	"
R430	QRD141J-752S	"	"	"
R431	QRD141J-224S	220 k	"	"
R432	QRD141J-224S	"	"	"
R433	QRD141J-561S	560	"	"
R434	QRD141J-561S	"	"	"
R435	QRD141J-111S	110	"	"
R436	QRD141J-111S	"	"	"
R441	QRZ0052-101	100	"	Fusible Δ
R442	QRZ0052-101	"	"	" Δ
R443	QRD141J-332S	3.3 k	"	Carbon
R444	QRD141J-332S	"	"	"
R445	QRD141J-564S	560 k	"	"
R446	QRD141J-564S	"	"	"
R447	QRD141J-683S	68 k	"	"
R448	QRD141J-683S	"	"	"
R449	QRD141J-223S	22 k	"	"
R450	QRD141J-223S	"	"	"
R451	QRD141J-391S	390	"	"
R452	QRD141J-391S	"	"	"
R453	QRD141J-103S	10 k	"	"
R454	QRD141J-103S	"	"	"
R455	QRD141J-102S	1 k	"	"
R456	QRD141J-101S	100	"	"
R461	QRD141J-103S	10 k	"	"
R462	QRD141J-103S	"	"	"
R463	QRD141J-103S	"	"	"
R464	QRD141J-103S	"	"	"
R465	QRD141J-103S	"	"	"
R466	QRD141J-104S	100 k	"	"
R467	QRD141J-103S	10 k	"	"
R468	QRZ0052-151	150	"	Fusible Δ
R469	QRZ0052-221	220	"	" Δ
R470	QRD141J-225S	2.2 M	"	Carbon
R471	QRD141J-103S	10 k	"	"
R472	QRD141J-823S	82 k	"	"
R473	QRD141J-103S	10 k	"	"
R474	QRD141J-103S	"	"	"
R475	QRD141J-682S	6.8 k	"	"
R476	QRD141J-682S	"	"	"
R477	QRD141J-333S	33 k	"	"
R478	QRD141J-333S	"	"	"
R479	QRD141J-563S	56 k	"	"
R480	QRD141J-475S	4.7 M	"	"
R499	QRD141J-475S	"	"	"
VR403	QVZ5010-008			S. Variable
VR404	QVT3C6W-6F5			Variable

Resistors

Item No.	Part Number	Rating		Description
R401	QRD141J-124S	120 k	1/4 W	Carbon (for B, C)
R402	QRD141J-124S	"	"	" (")
R409	QRD141J-152S	1.5 k	"	"
R410	QRD141J-152S	"	"	"
R411	QRD141J-5R6S	5.6	"	"
R412	QRD141J-5R6S	"	"	"
R413	QRD141J-473S	47 k	"	"
R414	QRD141J-473S	"	"	"
R415	QRD141J-471S	470	"	"
R416	QRD141J-471S	"	"	"
R417	QRD141J-362S	3.6 k	"	"
R418	QRD141J-362S	"	"	"
R419	QRD141J-362S	"	"	"

Others

Item No.	Part Number	Rating	Description
J401	E65396-001		Earth Plate
J402	EMN00TV-402A		Pin Jack Assy
J403	EMN00TV-402A		"
J404	EMN00TV-402A		"
P401	E03623-003		DIN Socket
	QMV5005-004		4P Plug Assy
	E68820-001		Shield Plate (for D)
SW401	QST4641-E01		Push Switch

Others

Item No.	Part Number	Rating	Description
SW402	QST4641-E01		Push Switch
SW403	QST4641-E01		"
SW404	QST4641-E01		"
SW405	QST4641-E01		"
SW411	ESP0001-007		"
SW412	ESP0001-007		"
SW413	ESP0001-007		"
SW414	ESP0001-007		"
SW415	ESP0001-007		"
	E10740-001		Circuit Board

8-(6) TPS-333 □ Fuse, Power Supply & AC Outlet P.C. Board Ass'y

Note: TPS-333 □-1 varies according to the areas employed. See note (1).

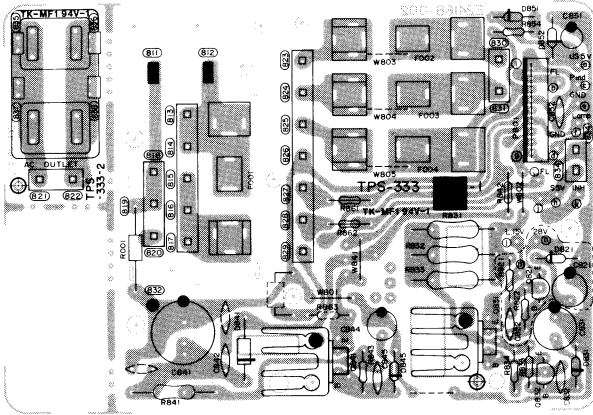

Fig. 21

Note (1)

Designated Areas	P. C. Board Ass'y
West Germany	TPS-333 P
Canada	TPS-333 M
U.S. Military Market & Other Countries	TPS-333 N
U.S.A.	TPS-333 R
Europe & Australia	TPS-333 O
U.K.	TPS-333 QBS

Note (2)

The symbols (赤, 黒, 白 etc) on P.C. Board surface are factory process only.

Each Individual P.C. Board Location

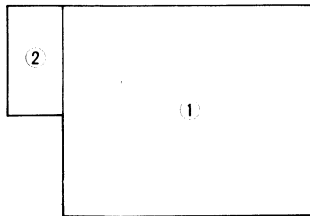

- ① TPS-333-1 Fuse & Power Supply P.C. Board Ass'y
- ② TPS-333-2 AC Outlet P.C. Board Ass'y

Fig. 22

Transistors

Item No.	Part Number	Rating	Description	Maker
Q821	2SD438 (D, E)		Silicon	Sanyo
Q831	2SD313V (D, E)		"	"
Q832	2SC945A (P, Q)		"	NEC
Q841	2SD438 (D, E)		"	Sanyo

Diodes

Item No.	Part Number	Rating	Description	Maker
D821	RD30EB3		Silicon	NEC
D831	RD16EB3		"	"
D841	ERB12-02RKL1		"	Fujidenki
D845	RD6.2EB3		"	NEC
D851	1S2076-31		"	Hitachi
D852	RD5.1EB2		"	NEC

Capacitors

Item No.	Part Number	Rating	Description
C821	QET51VM-107	100 μ F 35 V	Electro
C822	QCF21HP-103	0.01 μ F 50 V	Ceramic
C841	QET51EM-477	470 μ F 25 V	Electro
C842	QCF21HP-103A	0.01 μ F 50 V	Ceramic
C844	QET51AM-107	100 μ F 10 V	Electro
C845	QCF21HP-103A	0.01 μ F 50 V	Ceramic
C851	QET51HM-475	4.7 μ F	Electro
C852	QFM81HK-223	0.022 μ F	Mylar

Resistors

Item No.	Part Number	Rating	Description
R001	QRC121K-275EM	2.7 μ F 1/2 W	Composi (for M, R)
R821	QRD149J-100S	10 1/4 W	U. Carbon Δ
R822	QRD148J-472S	4.7 k "	Carbon
R831	QRG027J-391	390 2 W	O.M. Film Δ
R832	QRG027J-181	180 "	" Δ
R833	QRG027J-181	" "	" Δ
R834	QRD149J-101S	100 1/4 W	U. Carbon Δ
R835	QRD148J-472S	4.7 k "	Carbon
R841	QRG017J-680S	68 1 W	O.M. Film Δ
R843	QRD148J-681S	680 "	Carbon
R853	QRD148J-102S	1 k "	"

Others

Item No.	Part Number	Rating	Description
	QMV5005-009		9P Plug Assy
	QMC0437-002		AC Socket (for M, N, R)
	E45524-002		Fuse Clip (for M, R)
	EMG7331-001		"
	E67764-102		(for O, P, Q) Terminal Assy
	E67764-103		W. Terminal
	E67764-107		Terminal Assy
	E65508-002		Tab
	SBSB3008Z		Tapping Screw
	E61537-006		Heat Sink
	E24168-001		Circuit Board
	E24168-001BS		Cir Board (for Q)

9. R-X60 Schematic Diagram

9-(1) Tuner & Pre Amp Section (For Power Amp. Schematic Diagram, refer to page 23)

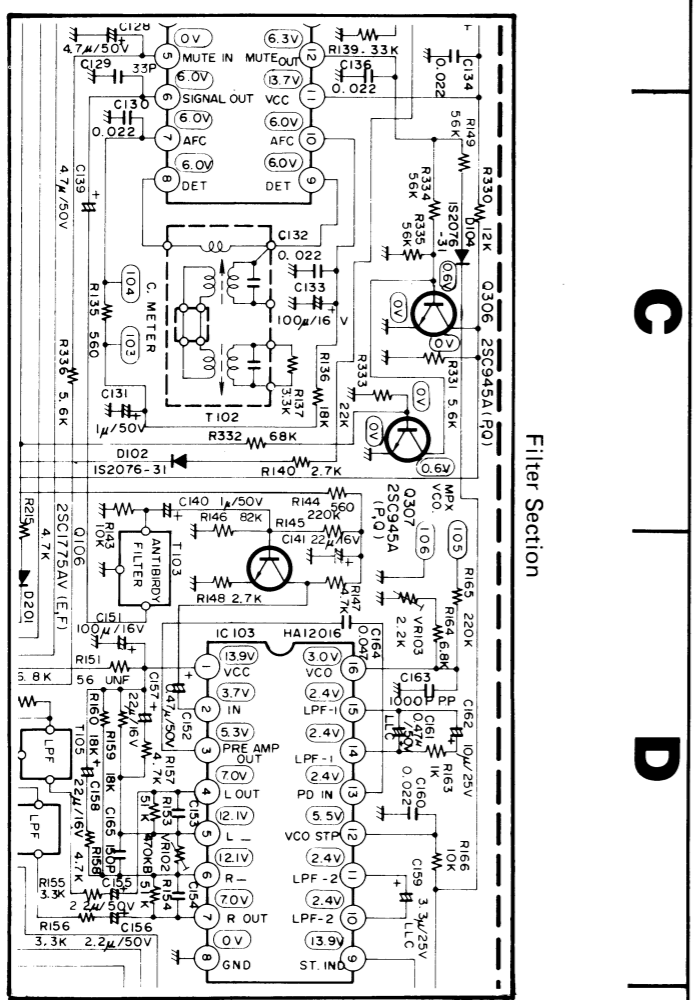
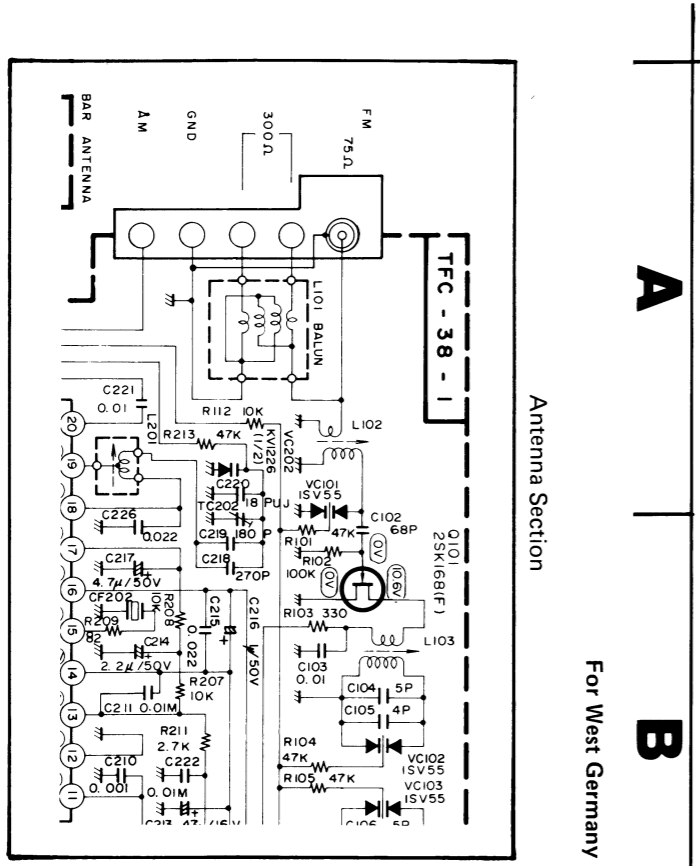
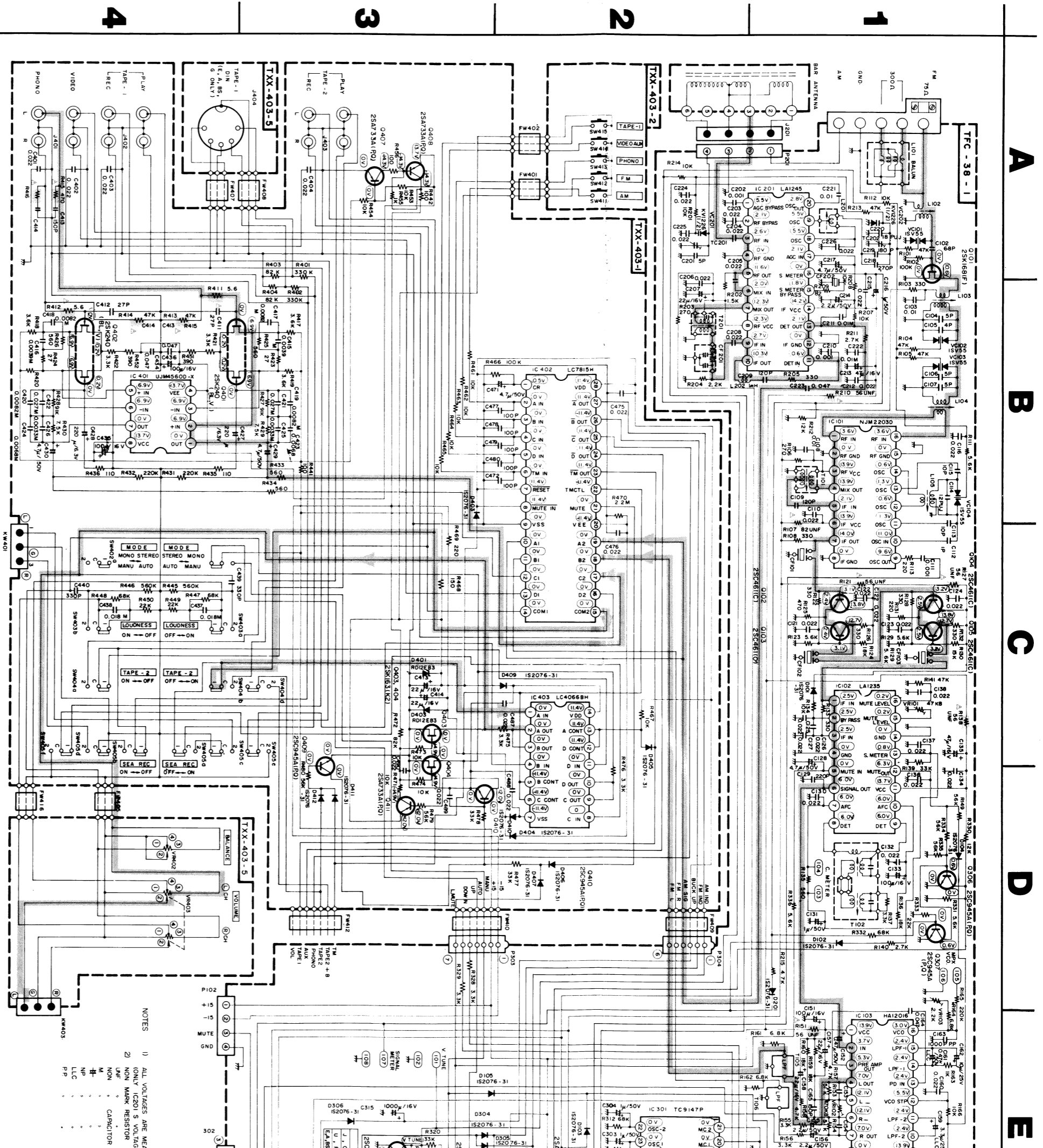

Printed Circuit Board

P.C. Board Ass'y	T	F
TFC-38		
TXX-403		

Notes:

1. shows DC voltage
2. indicates power point
3. indicates non-polar capacitor
4. indicates signal point
5. Parts in red indicate those to be replaced to ensure safety.
6. This is the standard design and notice.

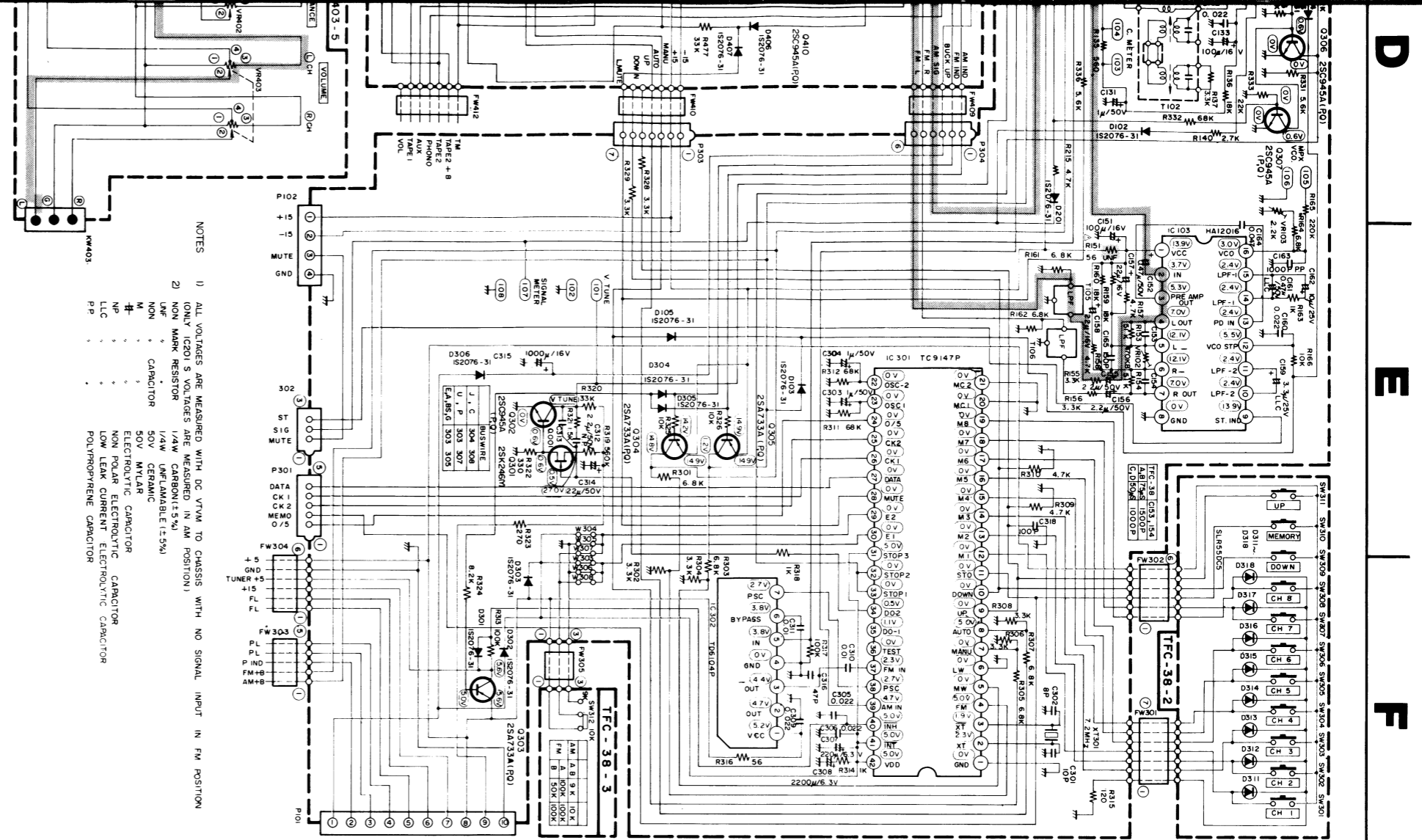

NOTES

- 1) ALL VOLTAGES ARE MEASURED WITH DC VTMV TO CHASSIS WITH NO SIGNAL INPUT IN FM POSITION. ONLY IC201 S VOLTAGES ARE MEASURED IN AM POSITION)
- 2) NON MARK RESISTOR 1/4W CARBON(±5%)
- 3) CAPACITOR 50V CERAMIC 1/4W INFLAMMABLE(±5%)
- 4) M 50V NYLAR
- 5) E ELECTROLYTIC CAPACITOR
- 6) NP NON POLAR ELECTROLYTIC CAPACITOR
- 7) LLC LOW LEAK CURRENT ELECTROLYTIC CAPACITOR
- 8) PP POLYPROPYLENE CAPACITOR

Printed Circuit Board Ass'y Location

P.C. Board Ass'y	Description	Page
TFC-38	Tuner P.C. Board Ass'y	10
TXX-403	Pre Amp P.C. Board Ass'y	19

- Notes:
1. shows DC voltage to the chassis with no signal input.
 2. indicates positive B power supply.
 3. indicates negative B power supply.
 4. indicates signal path.
- When replacing the parts in the darkened area () and those marked with , be sure to use the designated parts to ensure safety.
5. Parts in red indicate transistors or ICs.
 6. This is the standard circuit diagram.
- The design and contents are subject to change without notice.

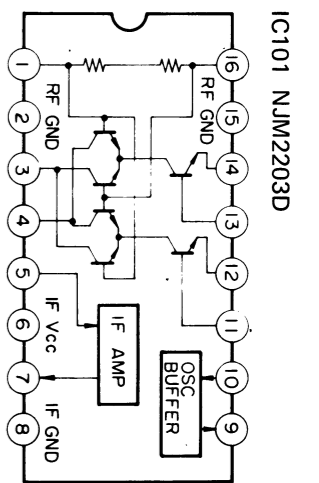

IC102 LA1235

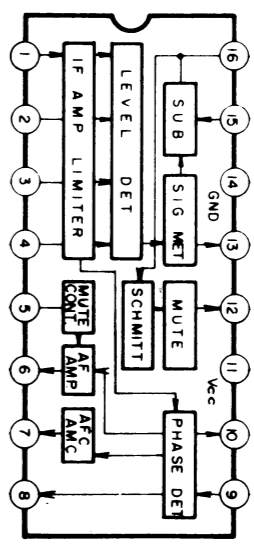

IC103 HA12016

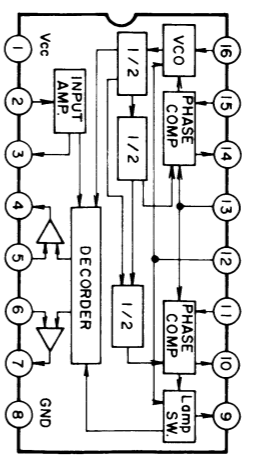

IC201 LA1245

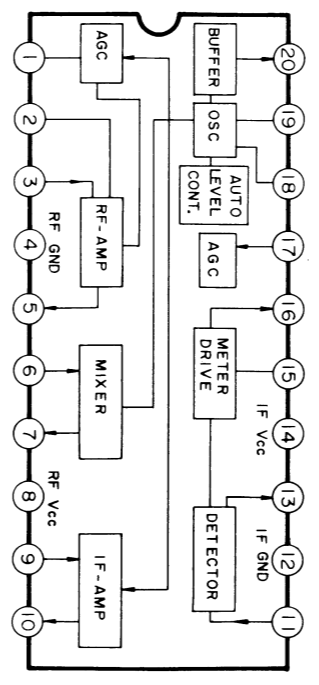

IC402 LC7815H

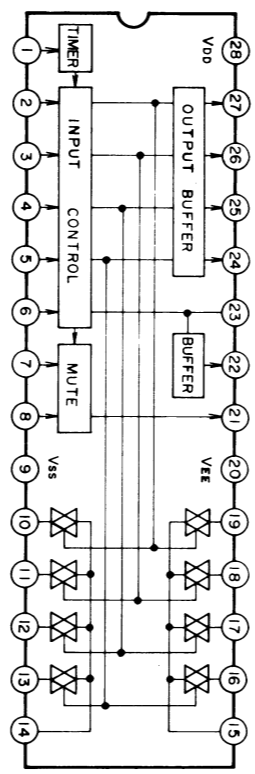

IC403 LC4066BH

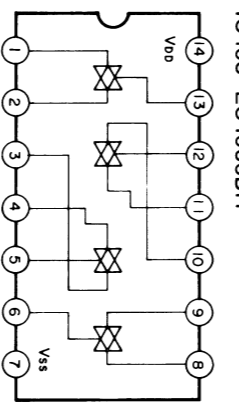

IC302 TD6104P

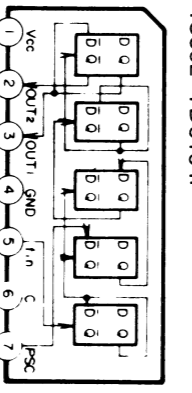

IC301 TC9147P

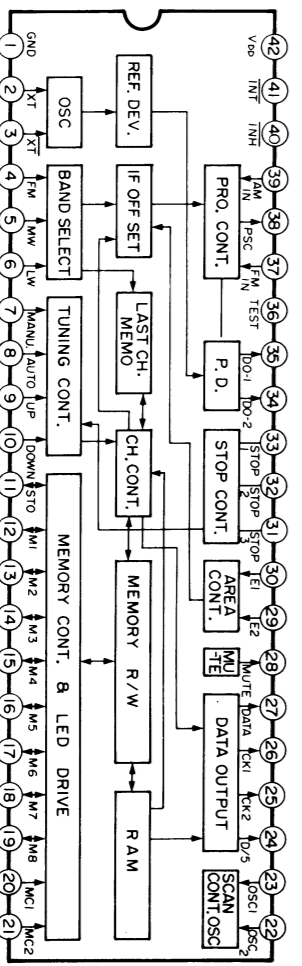

9-(2) Power Amp & Power Supply Section

A

B

C

D

E

(G) FOR WEST GERMANY : AC220V~50Hz (BS) FOR U.K. : AC240V~50Hz
 (E) FOR EUROPEAN COUNTRIES: AC220V~50Hz (A) FOR AUSTRALIA: AC240V~50Hz

(J) FOR U.S.A. : AC120V, 60Hz
 (C) FOR CANADA : AC120V, 60Hz

AC POWER SUPPLY SECTION

(P) FOR PACEX COUNT
 (U) FOR OTHER COUNT

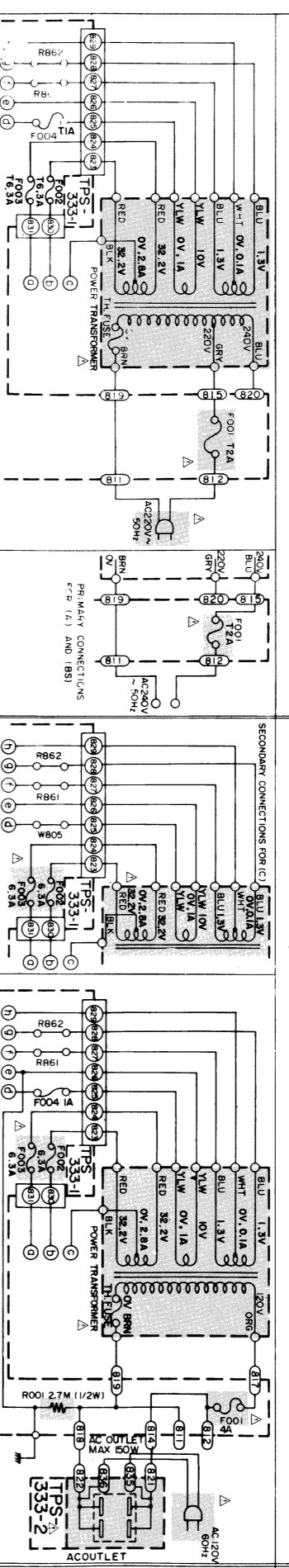

2

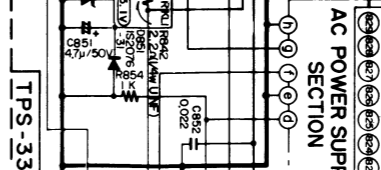
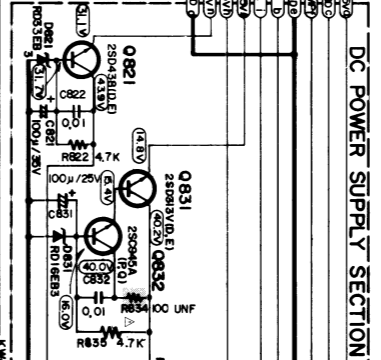
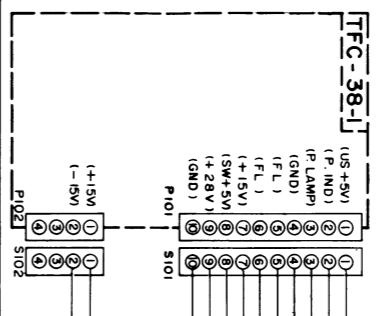
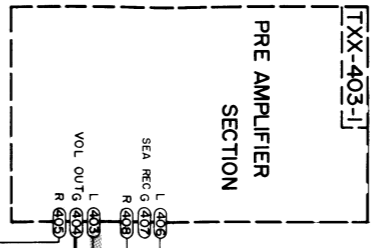

3

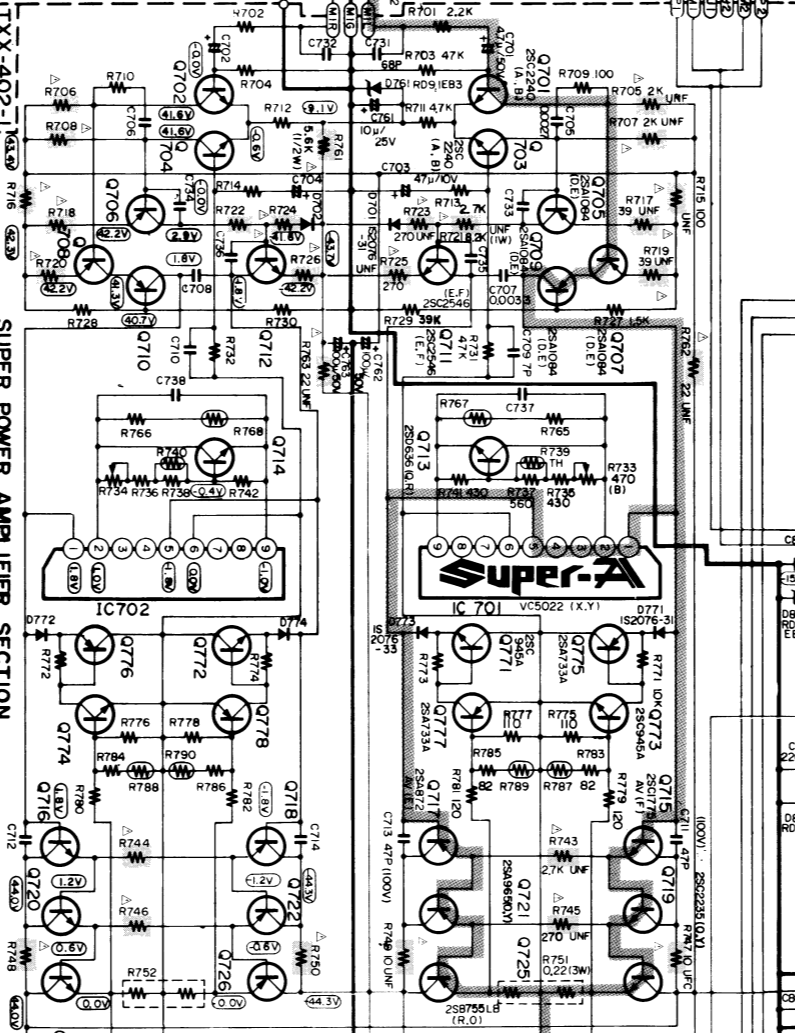
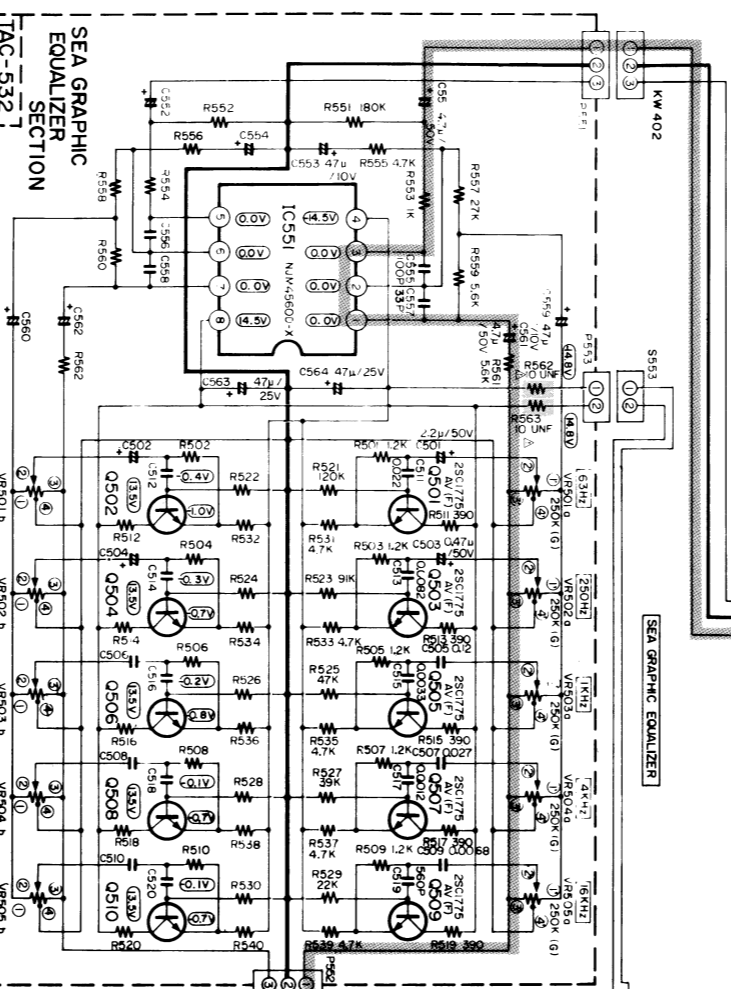

4

Printed Circuit Board Ass'y Location

P.C. Board Ass'y	Description	Page
TXX-402	Power Amp P.C. Board Ass'y	13
TAC-532A	SEA Control P.C. Board Ass'y	17
TRS-333	Fuse, Power Supply & AC outlet P.C. Board Ass'y	21

- Note:
- shows DC voltage to the chassis with no signal input.
 - indicates positive B power supply.
 - indicates negative B power supply.
 - indicates signal path.
- When replacing the parts in the darkened area (■) and those marked with △, be sure to use the designated parts to ensure safety.
- Parts in red indicate transistors or ICs.
 - The design and contents are subject to change without notice.

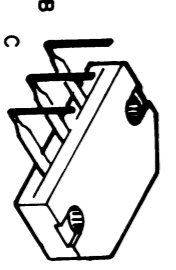

O801
2SD716 (O, R)

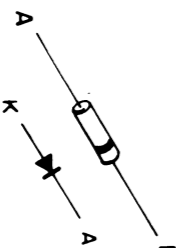
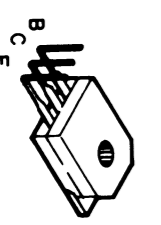

D801 ~ 804
S3V20F
D841
ERB12-02RKL1

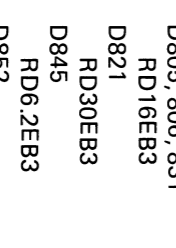
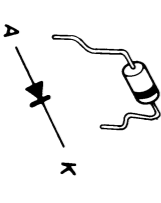

D801 ~ 804
S3V20F
D841
RD2.7EB2

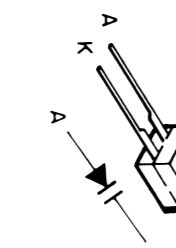
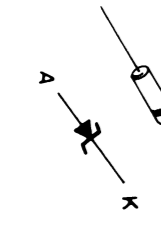

D311 ~ 318
SLR-55DC5F

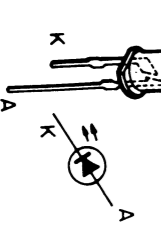

E F

(P) FOR PACEX : AC110,120,220,240V 50,60Hz
 (U) FOR OTHER COUNTRIES : AC110,120,220,240V 50,60Hz

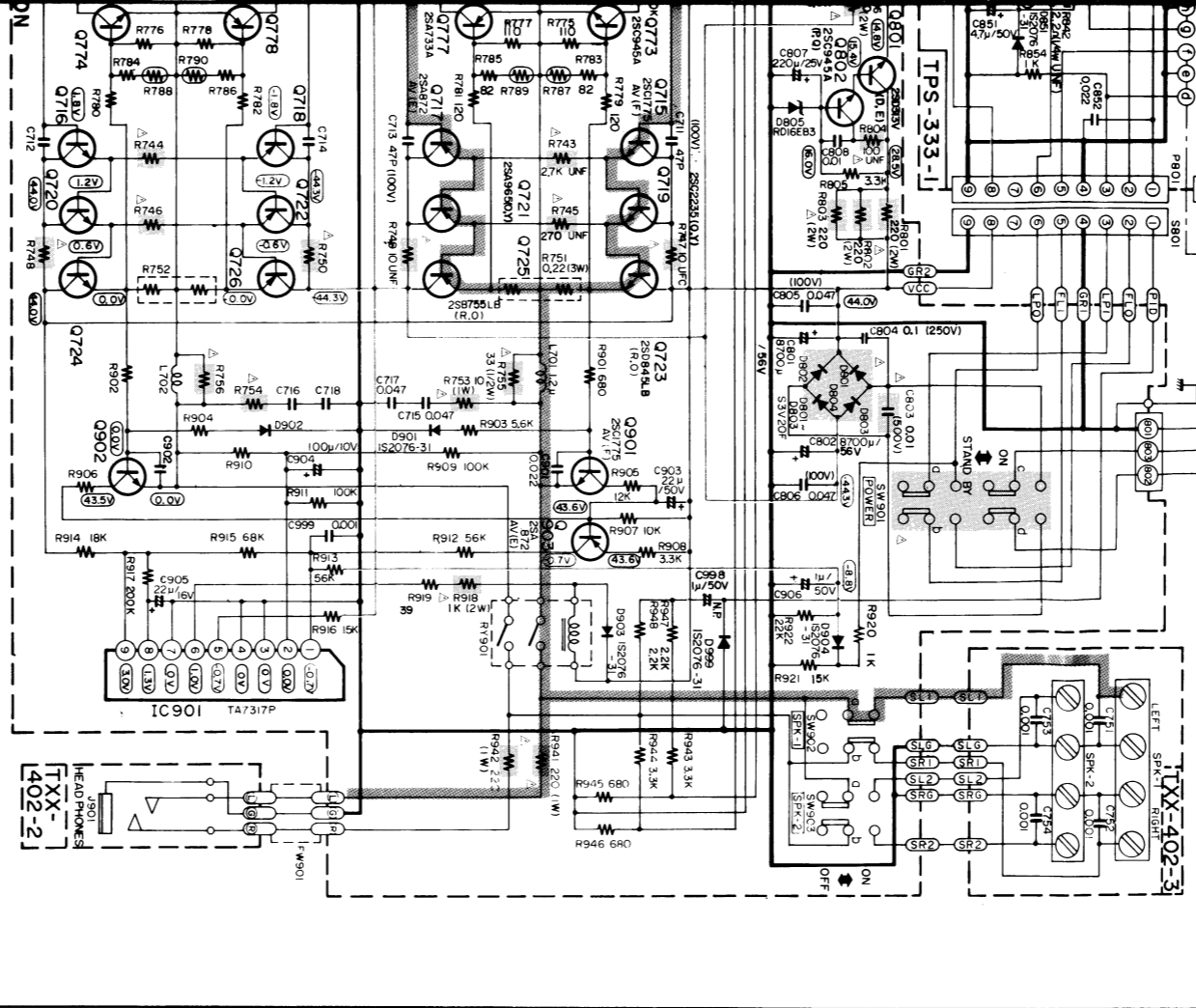
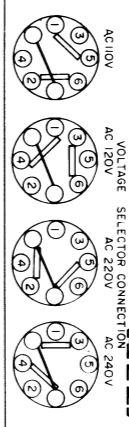
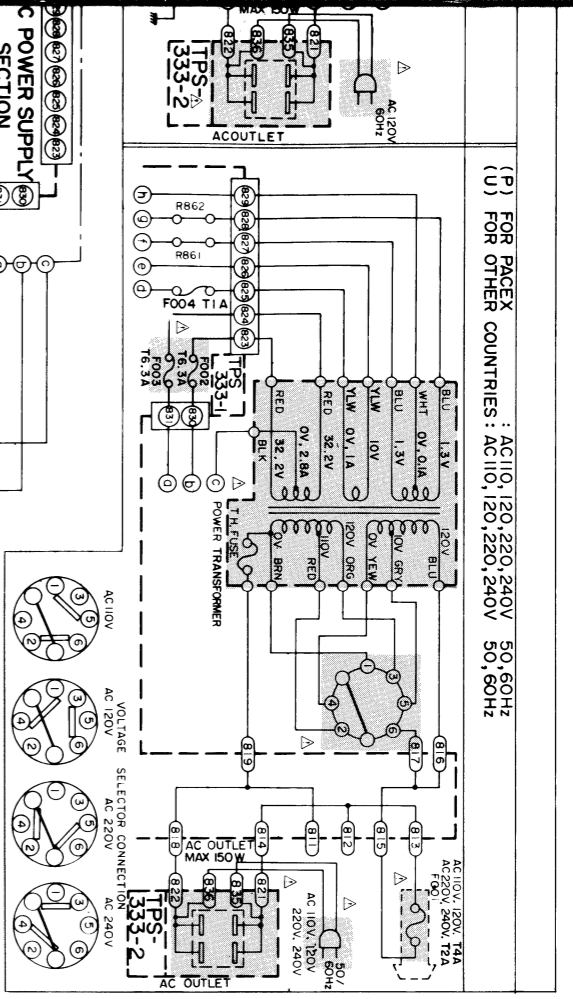

- IC101 NJM2203D
- IC102 LA1235
- IC103 HA12016
- IC201 LA1245

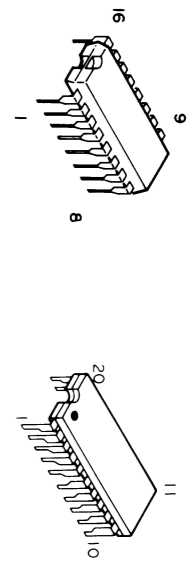

IC301 TC9147P

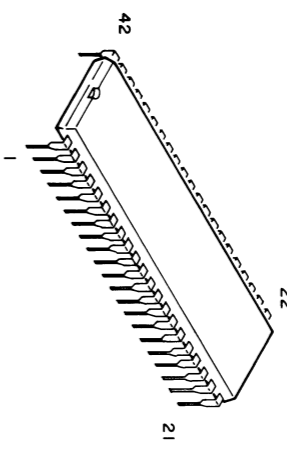

IC302 TD6104P



IC402 LC7815H

IC403 LC4066BH

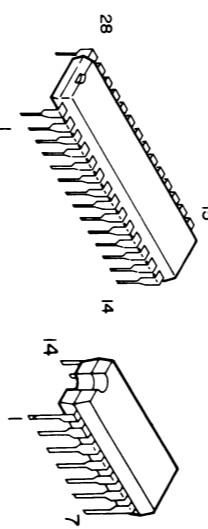

IC404 BA6208
 IC701, 702
 VC5022 (X, Y)

IC901
 TA7317P

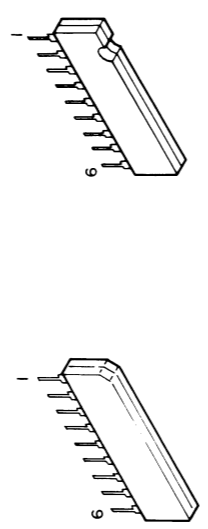

VC201, 202
 KV1226

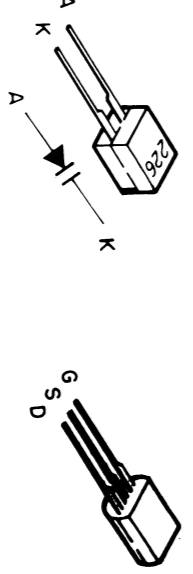

Q713, 714
 2SD636 (Q, R)

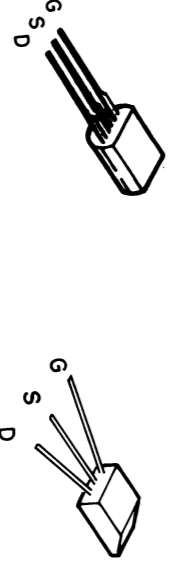

VC101 ~ 104
 1SV55

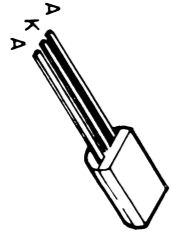

O803
 2SB507V (D, E)
 O831, 841
 2SD313V (D, E)

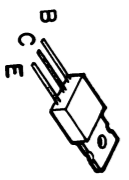

D311 ~ 318
 SLR-55DC5F

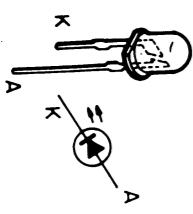

O301
 2SK246 (Y)
 O403, 404
 2SK163 (K2)



O102 ~ O105
 2SC461 (C)
 O106, 715, 716, 901, 902
 O501 ~ 510
 2SC1775AV (F)
 O302, 306, 307,
 O409, 410, 771 ~ 774,
 O802, 832
 2SC945A (P, Q)
 O303 ~ 305, 407, 408, 411
 O719, 720
 2SA733A (P, Q)
 O821
 2SD438



O701 ~ 704
 2SC2240 (A, B)
 O705 ~ 710
 2SA1084 (D, E)
 O711, 712
 2SC2546 (E, F)
 O717, 718, 775 ~ 778
 O903
 2SA872AV (E)
 2SC2238(O, Y)
 O721, 722
 2SA965(O, Y)

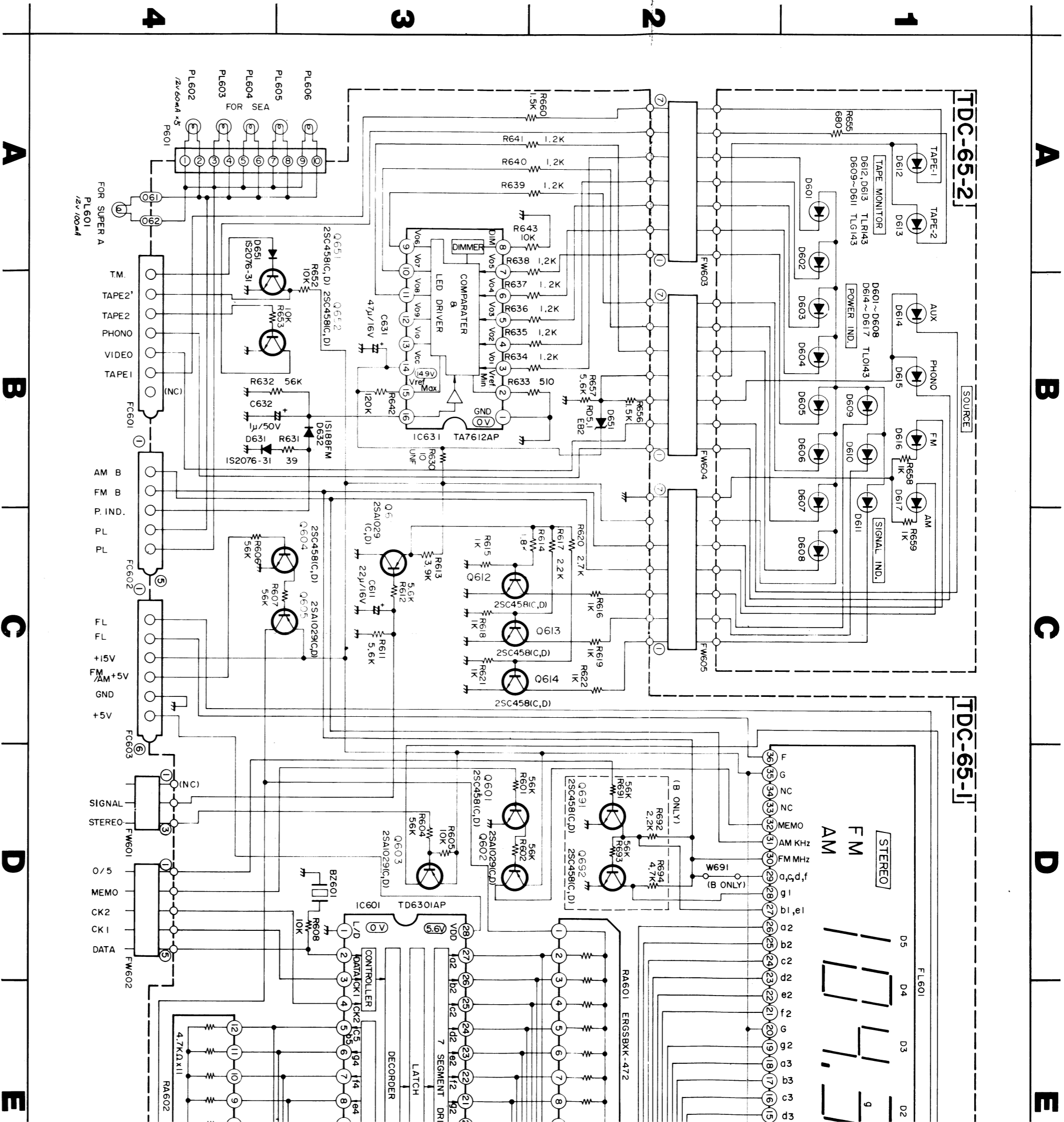

- Notes:
1. _____ indicates positive B power supply.
 2. Parts in red indicate transistors or ICs.
 3. This is the standard circuit diagram.
The design and contents are subject to change without notice.

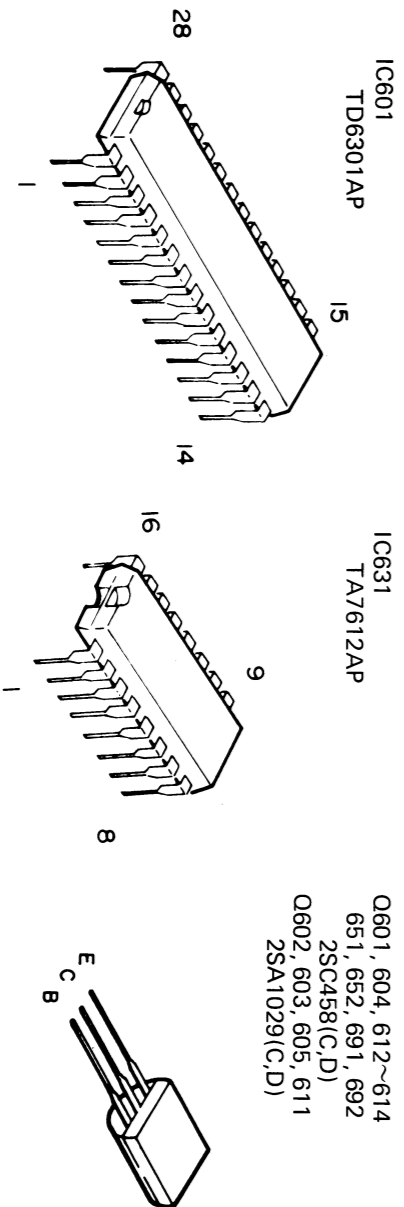

D E F

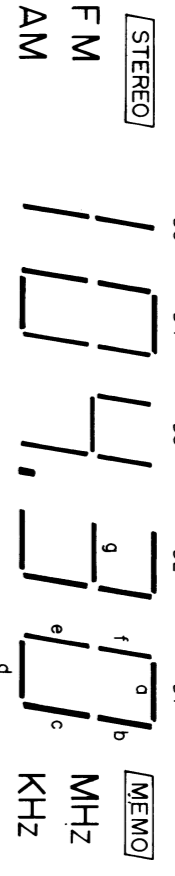
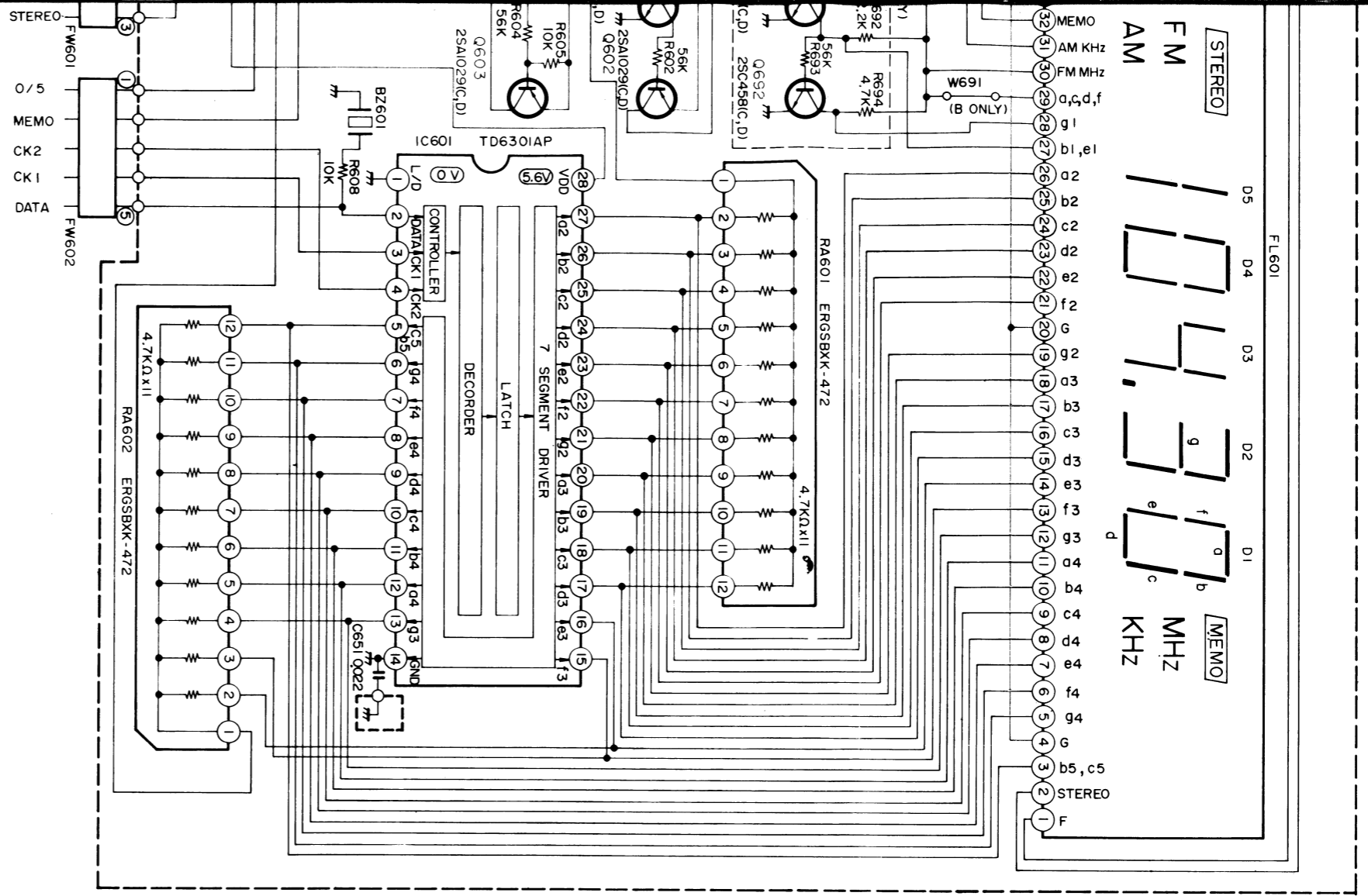

D E F

D601, 604, 612~614
651, 652, 691, 692
2SC458(C,D)
D602, 603, 605, 611
2SA1029(C,D)

D632
1S188FM
D631, 652
1S2076-31

D651
RD5.1EB2

D601~608, 614~617
TL0143
D612, 613
TLR143
D609~611
TLG143

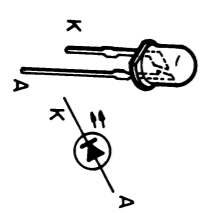
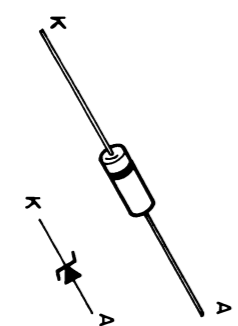
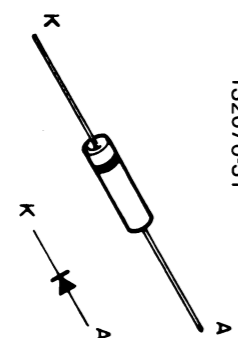
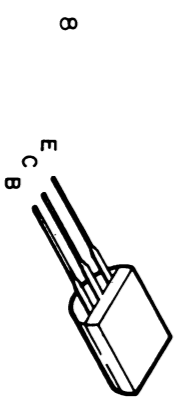

1 2 3 4

10. Packing Materials and Part Numbers

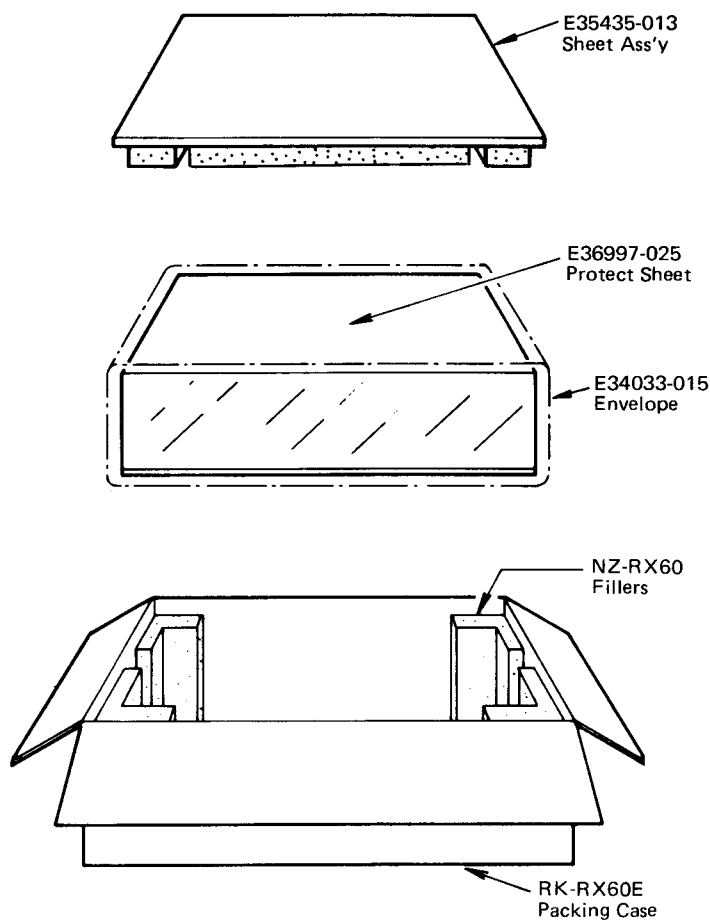

Fig. 23

11. Accessories List

Item No.	Description	USA (& Canada)	US Military Market (& Other Countries)	Europe	West Germany	Australia	U.K.
1	Instruction Book	E30580-1018A (")	E30580-1018A (")	E30580-1018A	E30580-1018A	E30580-1018A	E30580-1018ABS
2	Warranty Card	BT20048 (BT20025E)	BT20048 (-)	-	BT20057	BT20029C	BT20013C
3	Service Information Card	BT20046A (-)	BT20046A (-)	-	-	-	-
4	Safety Instruction	BT20044D (-)	-	-	-	-	-
5	Siemens Plug	-	E04056 (")	-	-	-	-
6	FTZ I. Sheet	-	-	-	BT20054-001A	-	-
7	Built-in Antenna	E03614-004 (")	E03614-004 (")	E03614-004	E03614-004	E03614-004	E03614-004
8	Envelope (for Inst.)	E41202-2 (")	E41202-2 (")	E41202-2	E41202-2	E41202-2	E41202-2

12. Parts List with Specified Numbers for Designated Areas

Item No.	Description	U.S.A. & Canada	U.S. Military Market & Other Countries	Europe	West Germany	Australia	U.K.
1	Fuse Holder Δ	—	QMG0301-003	—	—	—	—
2	Fuse (Primary) Δ	QMF61U1-4R0 (4A - 125 V)	QMF51A2-4R0S (T4A) or QMF51A2-2R0L (T2A)	QMF51A2-2R0L (T2A)	QMF51A2-2R0L (T2A)	QMF51A2-2R0L (T2A)	QMF51A2-2R2LBS (T2A)
3	Power Cord Δ	QMP1200-200	QMP7600-250	QMP3900-200	QMP3900-200	QMP2560-244	QMP9017-008BS
4	P. Cord Stopper Δ	QHS3876-162	QHS3876-162	QHS3876-162	QHS3876-162	QHS3876-162	QHS3876-162BS
5	Rear Panel	E24190-003	E24190-003	E24190-004	E24190-004	E24190-004	E24190-004
6	AC Outlet Δ	QMC0437-002	QMC0437-002	—	—	—	—
7	Voltage Selector Δ	—	QSR0085-001U	—	—	—	—
8	DIN Socket	—	—	E03623-003	E03623-003	E03623-003	E03623-003
9	AM Channel Space Switch	QSS2201-004	QSS2201-004	—	—	—	—
10	Antenna Terminal	E3572-021	E03572-021	E03572-021	EMB01YV-401A	E03572-021	E03572-021
11	Top Cover	E24194-001	E24194-001	E24200-002 (Metal) E23862-003 (Gril) E302271-001	E24194-001	E24194-001	E24200-002 (Metal) E23862-003 (Gril) E302271-001
12	Primary Cover Δ	—	—	QMF51A2-6R3S	E302271-001	E302271-001	E302271-001
13	Fuse (Secondary-1) Δ	QMF61U1-6R3	QMF51A2-6R3	QMF51A2-6R3S	QMF51A2-6R3S	QMF51A2-6R3S	QMF51A2-6R3SBS
14	(Secondary-2) Δ	QMF61U1-1R0	QMF51A2-1R0L	QMF51A2-1R0L	QMF51A2-1R0L	QMF51A2-1R0L	QMF51A2-1R0LBS
15	Power Transformer Δ	ETP1150-09JA	ETP1150-09FA	ETP1150-09EA	ETP1150-09EA	ETP1150-09EA	ETP1150-09EABS
16	Push Switch Δ (Power)	QSP0020-003	QSP0020-003	QSP0020-004	QSP0020-004	QSP0020-004	QSP0020-004BS
17	Tuner P.C. Board Ass'y	TFC-38A	TFC-38B	TFC-38C	TFC-38D	TFC-38C	TFC-38C
18	Power Amp "	TXX-402G	TXX-402G	TXX-402H	TXX-402I	TXX-402H	TXX-402H
19	Pre Amp "	TXX-403D	TXX-403D	TXX-403E	TXX-403F	TXX-403E	TXX-403E
20	Display "	TDC-65A	TDC-65B	TDC-65B	TDC-65B	TDC-65B	TDC-65B
21	Fuse "	TPS-333R (TPS-333M)	TPS-333N	TPS-333O	TPS-333P	TPS-333O	TPS-333QBS

Δ : Safety Parts

JVC

VICTOR COMPANY OF JAPAN, LIMITED, TOKYO, JAPAN